

New York State Energy Code

Manual

for Design Professionals

June 2019



NEW YORK
STATE OF
OPPORTUNITY.

NYSERDA

Acknowledgements

This document was prepared by the Building Codes Assistance Project (BCAP) for New York State Energy Research and Development Authority under Contract #49738 and is based on several focus group meetings, along with stakeholder feedback and industry research. The manual’s development, including focus groups, was facilitated by BCAP and funded by NYSERDA.

Special thanks to the following organizations and individuals:

International Code Council Newport Ventures Urban Green Council	
Focus group participants Douglas Arena, Bell and Spina Architects Peter Arsenault, PJ Arch Jeffrey Domanski, Institute for Building Technology and Safety (IBTS) Robert Kaczorowski, Watts Architecture & Engineering Kristin Maki, NYSERDA Ari Michelson, Energy & Resource Solutions (ERS) Ian Shapiro, Taitem Engineering Melanie Stachowiak, M/E Engineering Rachel Stuckey, Erdman Anthony Christa Waring, CTA Architects	Webinar participants Peter Arsenault, PJ Arch Ken Baker, K Energy Liza Bowles, Newport Ventures Ari Michelson, Energy & Resource Solutions (ERS) Darren Port, Northeast Energy Efficiency Partnerships (NEEP) Ian Shapiro, Taitem Engineering Melanie Stachowiak, M/E Engineering Christa Waring, CTA Architects

Table of Contents

Acknowledgements	ii
List of Figures	v
Acronyms and Abbreviations	vi
Definitions	vii
1 Introduction	1
1.1 The NYSERDA Energy Code Program.....	1
1.2 Intended Audience.....	2
1.3 Purpose of the Manual	2
2 Energy code basics	4
2.1 State History and Policy	4
2.1.1 Article 11.....	4
2.1.2 Article 18.....	4
2.1.3 American Recovery and Reinvestment Act.....	5
2.1.4 Executive Order 88.....	5
2.1.5 BuildSmart NY	5
2.1.6 Reforming the Energy Vision.....	6
2.1.7 Latest Energy Code Updates	7
2.1.8 2016 Energy Code Supplement	7
2.2 Development and Adoption Process	8
2.3 Compliance	10
2.4 Benefits and Challenges of Compliance	10
2.5 Legal and Ethical Obligations of Professional Licensure	11
3 Where to Start?	12
3.1 Chapters of the Energy Code.....	12
3.2 What is Covered by the Energy Code?.....	12
3.3 How to Use the Energy Code	12
3.3.1 Identify Project Type	13
3.3.2 Residential or Commercial?	13
3.3.3 New Construction or Existing Building?	14
3.3.4 Identify Project Climate Zone.....	14
3.3.5 Select Compliance Path.....	15
3.3.6 Prescriptive Path.....	16
3.3.7 Performance Path.....	17
3.3.8 Complete Documentation	19
3.4 Overview of Major ECCCNY-2016 Changes	19
3.5 NYC/NYS Code Differences	19

4	Commercial Energy Efficiency	20
4.1	Introduction.....	20
4.2	Definitions	20
4.3	Major Commercial Code Changes	21
4.4	Detailed Commercial Code Provisions	21
4.5	Additional Commercial Code Provisions.....	57
4.6	Frequently asked questions	58
4.6.1	C401 General.....	58
4.6.2	C402 Building Envelope Requirements	59
4.6.3	C403 Building Mechanical Systems	63
4.6.4	C404 Service Water Heating (Mandatory).....	64
4.6.5	C405 Electric Power and Lighting Systems.....	65
4.6.6	C406 Additional Efficiency Package Options	65
4.6.7	C408 System Commissioning	65
4.6.8	C501 Existing Buildings	65
4.6.9	C502 Additions	66
4.6.10	C503 Alterations.....	66
5	Residential Energy Efficiency	67
5.1	Introduction.....	67
5.2	Definitions	67
5.3	Major Residential Code Changes	68
5.4	Detailed Residential Code Provisions.....	68
5.4.1	R403.11 Portable Spas (Mandatory).....	82
5.4.2	R505 Change of occupancy or use	86
5.5	Additional residential code provisions.....	87
5.6	Frequently asked questions	87
5.6.1	R401 General	87
5.6.2	R401.2 Compliance.....	88
5.6.3	R402 Building Thermal Envelope	88
5.6.4	R402.2 Specific insulation requirements (Prescriptive).....	88
5.6.5	R403 Systems	90
5.6.6	R404 Electric Power and Lighting Systems.....	92
5.6.7	R405 Simulated Performance Alternative	92
5.6.8	R501 Existing Buildings	92
5.6.9	R502 Additions	93
5.6.10	R503 Alterations.....	93
5.6.11	Documentation and Inspections.....	94
	Appendix A: ECCCNYS-2016 Commercial Prescriptive Tables.....	A1
	Appendix B: ECCCNYS-2016 Residential Prescriptive Tables.....	B1

Appendix C: Additional Tools and Resources	C1
Appendix D: Image credits.....	D1

List of Figures

Figure 1. NYS source EUI reductions in State buildings since 2011	6
Figure 2. Main documents of the ECCCNY-2016	7
Figure 3. Composition of the NYS Code Council	8
Figure 4. Notice of adoption for the ECCCNY-2016	9
Figure 5. Major steps towards energy code compliance.....	13
Figure 6. New York climate zone map.....	15
Figure 7. ECCCNY-2016 compliance path options.....	16
Figure 8. Screen capture from COMcheck software.....	17
Figure 9. Tight-fitting door requirements for natural-draft fireplaces.....	23
Figure 10. Requirements for certain new wood-burning fireplaces and fireplace units.....	23
Figure 11. Varieties of commercial doors.....	24
Figure 12. A code compliant stucco wall assembly.....	25
Figure 13. Types of chillers.....	27
Figure 14. Example of a complex commercial HVAC system with chiller	28
Figure 15. AHRI 550/590 test conditions for water-cooled centrifugal chilling packages.....	29
Figure 16. Schematic diagram of a typical rooftop commercial air-handling unit.....	30
Figure 17. Main components of a water-cooled centrifugal chiller	30
Figure 18. Commercial kitchen exhaust system	33
Figure 19. Potential air leakage spots in exhaust systems.....	33
Figure 20. Air-side economizer.....	35
Figure 21. DWHR unit showing placement of heat exchanger	50
Figure 22. Pools and permanent spas.....	52
Figure 23. Wall with partial structural sheathing at corner.....	70
Figure 24. Sunroom insulation requirements.....	71
Figure 25. Plan view of a tenant separation wall between adjacent dwelling units.....	73
Figure 26. Example of heat trace system leading to residential bathroom	74
Figure 27. Detail of electric heat tracing cable with attachment tape	74
Figure 28. Demand recirculation system cycle	76
Figure 29. Typical system using a cold-water supply line.....	76
Figure 30. Snow and ice melt system sensor placement.....	78
Figure 31. Comprehensive energy label for a portable spa.....	82

Acronyms and Abbreviations

AHU.....	Air-handling unit
APSP.....	Association of Pool and Spa Professionals
ARRA.....	American Recovery and Reinvestment Act
ASHRAE.....	American Society of Heating, Refrigerating and Air-Conditioning Engineers
BASC.....	Building America Solutions Center
BCAP.....	Building Codes Assistance Project
BECF.....	Building Energy Codes Program
CI.....	Continuous insulation
CPA.....	Compliance Planning Assistance
DHWR.....	Drain water heat recovery
DOS.....	New York State Department of State
ECCCNYS.....	Energy Conservation Construction Code of New York State
ERI.....	Energy Rating Index
ERV.....	Energy recovery and ventilation
HRV.....	Heat recovery and ventilation
HERS.....	Home energy rating system
IBC.....	International Building Code
IECC.....	International Energy Conservation Code
IMC.....	International Mechanical Code
IRC.....	International Residential Code
LEED.....	Leadership in Energy and Environmental Design
NYSERDA.....	New York State Energy Research and Development Authority
PNNL.....	Pacific Northwest National Laboratory
SHGC.....	Solar heat gain coefficient
SIPs.....	Structural insulated panels
US DOE.....	U.S. Department of Energy
WHMV.....	Whole-house mechanical ventilation

Definitions

These terms, also found in Sections C202 and R202, are applicable to both commercial and residential buildings. Terms specific to commercial or residential buildings are listed under the respective sections.

Accessible	Admitting close approach as a result of not being guarded by locked doors, elevation, or other effective means (see “Readily accessible”)
Addition	An extension or increase in the conditioned space floor area or height of a building or structure.
Air barrier	Materials assembled and joined together to provide a barrier to air leakage through the building envelope. An air barrier may be a single material or a combination of materials.
Alteration	Any construction, retrofit, or renovation to an existing structure other than repair or addition that requires a permit. Also, a change in a building, electrical, gas, mechanical or plumbing system that involves an extension, addition or change to the arrangement, type or purpose of the original installation that requires a permit.
Building site	A contiguous area of land that is under the ownership or control of one entity.
Building system	A combination of central or terminal equipment or components or controls, accessories, interconnecting means, and terminal devices by which energy is transformed to perform a specific function, such as heating, ventilation and air conditioning, service water heating or illumination.
Building thermal envelope	The exterior walls (above and below grade), floor, roof, and any other building elements that enclose conditioned space or provides a boundary between conditioned space and exempt or unconditioned space.
Climate zone	A geographical region based on climatic criteria as specified in this code.
Code official	The officer or other designated authority charged with the administration and enforcement of this code, or a duly authorized representative.
Conditioned space	An area or room within the thermal envelope of a building that is directly or indirectly heated or cooled using fossil fuel or electricity as the energy source. Spaces indirectly heated or cooled where they communicate through openings with conditioned spaces and separated from conditioned spaces by uninsulated walls, floors or ceilings, or contain uninsulated ducts, piping, or other sources of heating or cooling using fossil fuel or electricity.

Continuous air barrier	A combination of materials and assemblies that restrict or prevent the passage of air through the building thermal envelope.
Continuous insulation (CI)	Insulating material that is continuous across all structural members without thermal bridges other than fasteners and service openings. It is installed on the interior or exterior or is integral to any opaque surface of the building envelope.
Duct	A tube or conduit utilized for conveying air. The air passages of self-contained systems are not to be construed as air ducts.
Duct system	A continuous passageway for the transmission of air that, in addition to ducts, includes duct fittings, dampers, plenums, fans, and accessory air-handling equipment and appliances.
Dwelling unit	A single unit providing complete independent living facilities for one or more persons, including permanent provisions for living, sleeping, eating, cooking, and sanitation.
Energy analysis	A method for estimating the annual energy use of the proposed design and standard reference design based on estimates of energy use.
Energy Code	The New York State Energy Conservation Construction Code (ECCCNYS) adopted pursuant to Article 11 of the New York State Energy Law.
Exterior wall	Walls including both above-grade walls and basement walls.
Fenestration	Products classified as either vertical fenestration or skylights. <i>Vertical fenestration</i> Glass or other transparent or translucent glazing material installed at a slope of less than 60°(1.05 rad) from horizontal. <i>Skylights</i> Windows (fixed or moveable), opaque doors, glazed doors, glazed block, and combination opaque/glazed doors composed of glass or other transparent or translucent glazing materials and installed at a slope of at least 60° (1.05 rad) from horizontal.
Historic building	Any building that is (1) listed on the national register of historic places or on the State register of historic places; (2) determined by the commissioner of parks, recreation and historic preservation to be eligible for listing on the State register of historic places; (3) determined by the commissioner of parks, recreation and historic preservation to be a contributing building to an historic district that is listed or eligible for listing on the state or national registers of historic places; or (4) otherwise defined as an historic building in regulations adopted by the State fire prevention and building code council.

Infiltration	The uncontrolled inward air leakage into a building caused by the pressure effects of wind or the effect of differences in the indoor and outdoor air density or both.
Proposed design	A description of the proposed building used to estimate annual energy use for determining compliance based on total building performance.
Readily accessible	Capable of being reached quickly for operation, renewal, or inspection without requiring obstacle removal or the need for portable ladders or access equipment (see “Accessible”).
Repair	The reconstruction or renewal of any part of an existing building for its maintenance or to correct damage.
R-value (thermal resistance)	The inverse of the time rate of heat flow through a body from one of its bounding surfaces to the other surface for a unit temperature difference between the two surfaces, under steady state conditions per unit area ($h \cdot ft^2 \cdot ^\circ F/Btu$).
Solar heat gain coefficient (SHGC)	The ratio of the solar heat gain entering the space through the fenestration assembly to the incident solar radiation. Solar heat gain includes directly transmitted solar heat and absorbed solar radiation that is then reradiated, conducted, or convected into the space.
U-factor (thermal transmittance)	The coefficient of heat transmission (air-to-air) through a building component or assembly, equal to the time rate of heat flow per unit area and unit temperature difference between the warm side and cold side air films ($Btu/h \cdot ft^2 \cdot ^\circ F$).
Uniform Code	The New York State Uniform Fire Prevention and Building Code adopted pursuant to Article 18 of the New York State Executive Law, as currently in effect and as amended from time to time.
Ventilation	The natural or mechanical process of supplying conditioned or unconditioned air to, or removing such air from, any space.
Ventilation air	The portion of supply air that comes from outside (outdoors) plus any recirculated air treated to maintain the desired quality of air within a designated space.

1 Introduction

1.1 The NYSERDA Energy Code Program

The New York State Energy Research and Development Authority (NYSERDA) provides initiatives and incentives to move New York State toward increased energy efficiency and renewable energy use while reducing energy costs and reliance on fossil fuels. NYSERDA supports the Energy Code by providing technical assistance via contractors and tools to improve code compliance. The NYSERDA Energy Code Program is a key partner of the NYS Department of State (DOS), the State entity that administers, adopts, and prepares the code. The Energy Code Program includes training to industry stakeholders, research, and the development of a variety of support resources, a website, plan review and inspection services, and a real-time Energy Code help line. This manual will build on existing program efforts and be a component of future work.

In 2015 and 2016, BCAP conducted research for NYSERDA to garner insights from the design, construction, and enforcement markets to propose recommendations on ways to improve energy code compliance in the State. The BCAP Gap Analysis report bases its recommendations on findings from an online survey of 356 code enforcement officials and 79 other building professionals, and telephone interviews with 177 architects, engineers, construction professionals, code enforcement officials, building owners, and energy specialists.

According to the survey, architects and engineers in the State perceive the Energy Code as more complex and confusing than other building codes and need better code interpretations to properly design for code compliance. For example, architects said they need to understand the distinction between the prescriptive and performance path, along with energy modeling; the scope of certain specific code requirements exceptions; and commissioning in commercial buildings. Design professionals noted that better photos and images would aid them in visualizing potential problem areas within the code.

The New York State Gap Analysis report is part of BCAP's Compliance Planning Assistance (CPA) Program, a larger national program covering 25 states.¹ The CPA program worked with states to help them take practical steps towards achieving full compliance with the model energy codes. With new opportunities came new challenges, such as meeting 90% compliance by 2017, as required by American Recovery and Reinvestment Act (ARRA). This program offered states hands-on assistance to assess current energy code efforts and opportunities and develop action plans including essential information, technical resources, and recommendations for achieving state priorities and federal objectives.

Throughout the process, BCAP spoke with key stakeholders and conducted extensive information gathering. The in-depth research and analysis of the situation enabled targeted recommendations and data that accommodated State-specific circumstances and met reporting requirements. The CPA

¹ <https://bcapcodes.org/compliance-portal/cpa/>

Program also helped participating states navigate the wide array of federal and regional resources and services available, choosing the best fit for each state. There is commonality among all CPA states in the need to recognize the design community as a critical component to the success of energy code policies.

The State's Urban Green Council (UGC) training series is targeted specifically to the design community. The training strives to continually develop design professionals' familiarity, compliance and expertise in energy code applications. BCAP staff are trained to conduct the UGC's workshops, which upon completion of the series, will train thousands of design professionals. This manual will enhance the information presented in UGC's training guidebook *Conquer the Code* (updated December 2016), emphasize best practices, and otherwise complete the training guidebook. Participants of the UGC training receive a copy of the *Conquer the Code* guidebook and this manual provides additional information not covered by the guidebook.

1.2 Intended Audience

Design professionals represent a critical component in nationwide efforts to improve energy code compliance—the design team bears the lion's share of liability during design and construction, including all decisions pertaining to code compliance.

Successful energy code requirement compliance begins with knowledgeable application of those provisions by the design team in the earliest stages of the process. The manual will assist design professionals, architects, and engineers in improving energy efficiency and Energy Code compliance in both commercial and residential buildings. The content addresses regional diversity, as well as other design and construction variations.

1.3 Purpose of the Manual

The goal of this manual is to remove identified market barriers and fill in gaps, leading to full Energy Code compliance, focusing on the design community.

The manual serves as a practical, easy-to-use resource to improve Energy Code enforcement and compliance as standard practice within the design, construction, and inspection processes and will effectively translate the Energy Code information into actionable guidance. Along with *Conquer the Code* (updated December 2016) and other known resources, the manual will function as a companion to the residential and commercial provisions of the Energy Code.

Design professionals prefer training materials that explain the material concepts. Many complicated code provisions can best be explained via photographs or drawings, but there are few, if any, technical resources for designers that provide energy code information in this format. Designed to build a deep and sustained understanding of the Energy Code while being an easy-to-use reference during the design process, the manual is organized in a way that allows the user to easily navigate to the desired topic. The content includes both a series of clear guidelines for code compliance as well as a catalogue of best practices and techniques. There are combinations of text, graphics, building design drawings, tables,

graphs, charts, and checklists intended to be accessible in both electronic and print formats. The manual will also act as an educational tool to support a variety of audiences.

The manual will facilitate familiarity with the ECCCNY-2016, but not supersede it. It will build on and reference known source materials, such as ASHRAE's Advanced Energy Design Guides for multiple building types; New York State Conquering the Code 2012 training manual; code commentary manuals from New York and the International Code Council (ICC); and ASHRAE user's manuals, to ensure the information is technically correct and consistent. Where applicable, specific provisions of the Energy Code and sections of other publications have been referenced to easily guide the reader between resources. In terms of the Conquering the Code publication, this manual will enhance, fill in the gaps of omitted Code provisions, and emphasize best practices.

While this manual incorporates information that is consistent with good design practice, it is not intended to be a complete design resource. It does not comprehensively address all Energy Code requirements or other areas of design beyond energy efficiency. This manual focuses on the ECCCNY-2016, which governs all new construction and most additions, alterations, and renovations in the State as of October 3, 2016. Best practices to meet and exceed the minimum Energy Code are discussed, but high-performance building features (such as on-site renewable energy generation) or recognized beyond code rating programs are not included.

Please note the following:

- *Excerpts from the Energy Code are shown in gray italics.*
- *Excerpts from the Code and Commentary to the ECCCNY-2016 are shown in blue italics.*

2 Energy code basics

2.1 State History and Policy

New York State has used building codes to govern the construction of some of its buildings since the 1940s. Starting in 1979, new building construction and major alterations have been required to comply with the State's energy code. In general, building codes set the legal minimum standards by which residential and commercial buildings are designed, constructed, and operated. Energy codes, a subset of these standards, set minimum energy efficiency standards for building components and systems.

2.1.1 Article 11

The New York State Legislature added Article 11 to the Energy Law in 1978. Article 11 describes how the Energy Code is to be developed, maintained, administered, and enforced by the New York State Fire Prevention and Building Code Council (NYS Code Council):²

The state fire prevention and building code council is authorized, from time to time as it deems appropriate and consistent with the purposes of this article, to review and amend the code, or adopt a new code, through rules and regulations provided that the code remains cost effective with respect to building construction in the State.

2.1.2 Article 18

In 1981, the New York State Legislature adopted Article 18 of the Executive Law, which directed the development and implementation of a comprehensive building and fire prevention code that would cover buildings throughout the state.³ Prior to Article 18, building codes were under-regulated and inconsistent, and those that did exist were only implemented at the discretion of local jurisdictions. As stated in Article 18:

There does not exist for all areas of the state a single, adequate, enforceable code establishing minimum standards for fire protection and construction, maintenance and use of materials in buildings. Instead, there exists a multiplicity of codes and requirements for various types of buildings administered at various levels of state and local government. There are, in addition, extensive areas of the State in which no code at all is in effect for the general benefit of the people of the State...

² <https://law.justia.com/codes/new-york/2016/eng/article-11/>

³ <https://law.justia.com/codes/new-york/2016/exc/article-18/>

Article 18 also established the NYS Code Council within the Division of Housing and Community Renewal.⁴ This council develops, maintains, and periodically updates New York’s Uniform Fire Prevention and Building Code (Uniform Code) and the Energy Code. It also adopts More Restrictive Local Standards upon the recommendation of local governments. The NYS Code Council’s rules and regulations are overseen by the Secretary of State.

21.3 American Recovery and Reinvestment Act

The establishment of the American Recovery and Reinvestment Act of 2009, commonly known as the Recovery Act or ARRA, facilitated the advancement of energy code stringency around the country. ARRA provided two opportunities for states to receive stimulus funds linked to building energy codes: Energy Efficiency and Conservation Block Grants and State Energy Programs (SEPs). The NYS-approved SEP plan included \$4.4 million for the NYSERDA Energy Code program.⁵ This federal mandate for code compliance influenced State energy planning goals and efforts. The 2010 edition of the ECCCNY, which became effective in December 2010, satisfied ARRA’s more stringent requirements.⁶

21.4 Executive Order 88

In late 2012, Governor Andrew M. Cuomo signed Executive Order 88 (EO 88), which identified energy efficiency as one of the best strategies for achieving “the mutually compatible goals of environmental protection, energy security, and economic growth.”⁷ EO 88 set a source energy use intensity (EUI) reduction target for State-owned and managed government buildings. The order called for a 20% source EUI reduction compared to a 2010 baseline. The progress towards this 2020 target, an 8.8% reduction in the source EUI of state facilities since 2011, is shown in Figure 1.

21.5 BuildSmart NY

To coordinate these efforts, BuildSmart NY was created to provide management, coordination, technical assistance, and resources of the many State agencies working to improve their buildings.⁸

⁴ <http://www.nysl.nysed.gov/reference/building/>

⁵ <https://www.rfcuny.org/RFWebsite/News/DetailNews.aspx?newsID=2086>

⁶ https://www.dos.ny.gov/dcea/energy_faq.html

⁷ <http://www.governor.ny.gov/news/no-88-directing-state-agencies-and-authorities-improve-energy-efficiency-state-buildings>

⁸ <http://www.nypa.gov/innovation/programs/buildsmart-ny>

Figure 1. NYS source EUI reductions in State buildings since 2011

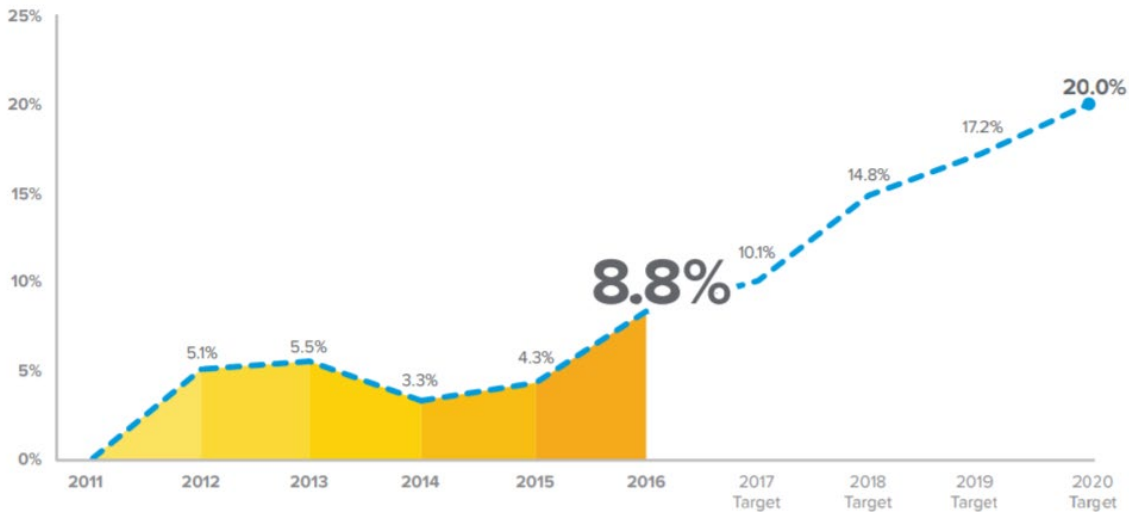

21.6 Reforming the Energy Vision

In 2014, Governor Cuomo launched Reforming the Energy Vision (REV), a strategy to reform the State energy policy and initiatives to build a clean, resilient, and affordable energy system and to achieve an 80% reduction in greenhouse gas emissions by 2050.⁹ One project under the REV umbrella is the Clean Energy Communities initiative, which designates those communities that have completed at least four of 10 high-impact clean energy actions. One of these action items is the completion of energy code enforcement training for municipal code official staff.¹⁰

New York is a long-standing supporter of energy-efficient buildings and above-code programs. Some of the State's recent code-related efforts include:

- The Commercial New Construction Program, the Multifamily Performance Program, the Residential New Construction (low-rise) program, and the New York ENERGY STAR® Certified Homes standard.¹¹
- A forthcoming voluntary NYS Stretch Code that will include energy efficiency provisions that exceed the State mandated Energy Code.

⁹ <https://rev.ny.gov/>

¹⁰ nysersda.ny.gov/All-Programs/Programs/Clean-Energy-Communities/Action-Items

¹¹ nysersda.ny.gov/Business-and-Industry/Housing-and-Development

21.7 Latest Energy Code Updates

On March 9, 2016, the NYS Code Council updated and adopted both the residential and commercial provisions of the Energy Code. These updates went into effect on October 3, 2016. The residential and commercial provisions of the Energy Code are based on the 2015 IECC as modified by the 2016 Energy Code Supplement. For commercial buildings, the 2015 IECC also allows compliance to be shown using ASHRAE 90.1-2013. The main documents comprising the ECCCNYS-2016 are shown in Figure 2.

Figure 2. Main documents of the ECCCNYS-2016

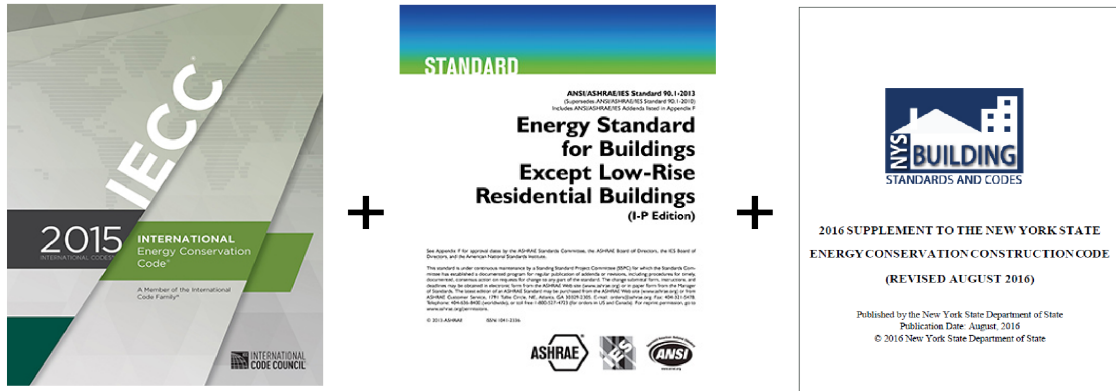

21.8 2016 Energy Code Supplement

The 2016 Energy Code and 2016 Uniform Code are largely based on ICC's 2015 I-Codes. The 2016 Energy Code references the 2015 IECC and ASHRAE 90.1-2013. The State-specific modifications and additions to these model energy codes are detailed in the 2016 Energy Code Supplement.

When referring to a section in the 2015 IECC or ASHRAE 90.1-2013, it is important to also check the 2016 Energy Code Supplement to see if and how that provision is amended.

The 2016 Uniform Code principally references the following I-Codes:

- 2015 International Building Code (IBC)
- 2015 International Fire Code
- 2015 International Fuel Gas Code
- 2015 International Mechanical Code (IMC)
- 2015 International Plumbing Code
- 2015 International Property Maintenance Code
- 2015 International Residential Code (IRC)
- 2015 International Existing Building Code

As the various articles, executive orders and laws have changed throughout the years, the content has become increasingly complex. This manual, along with other resources, were created to help sift through the dense material and provide clarity to achieve what the Energy Code and laws were set out to do.

2.2 Development and Adoption Process

The State’s building codes are based on the ICC’s I-Codes. Every three years, ICC stakeholders convene to submit proposals, vote, and ultimately develop new versions of the I-Codes, including the IECC. The ASHRAE Standard 90.1 development process is different from the ICC’s method. Like the IECC revision, the ASHRAE process is an open forum, but it is among working committees made up of a diverse set of relevant stakeholders. The committees then open revision proposals for public comment. Once the committee reaches a majority consensus, it submits the proposals to the ASHRAE Board for approval. ASHRAE publishes Standard 90.1 on a three-year cycle, but proposals are accepted at any time.¹²

The State updates its building codes via regulatory action. Unlike many states, but similar to I-Codes and ASHRAE, New York follows a triennial adoption cycle for all its building codes, reviewing and proposing amendments to model codes soon after their publication. Smaller interim corrections and supplements are also released as needed.

Figure 3. Composition of the NYS Code Council

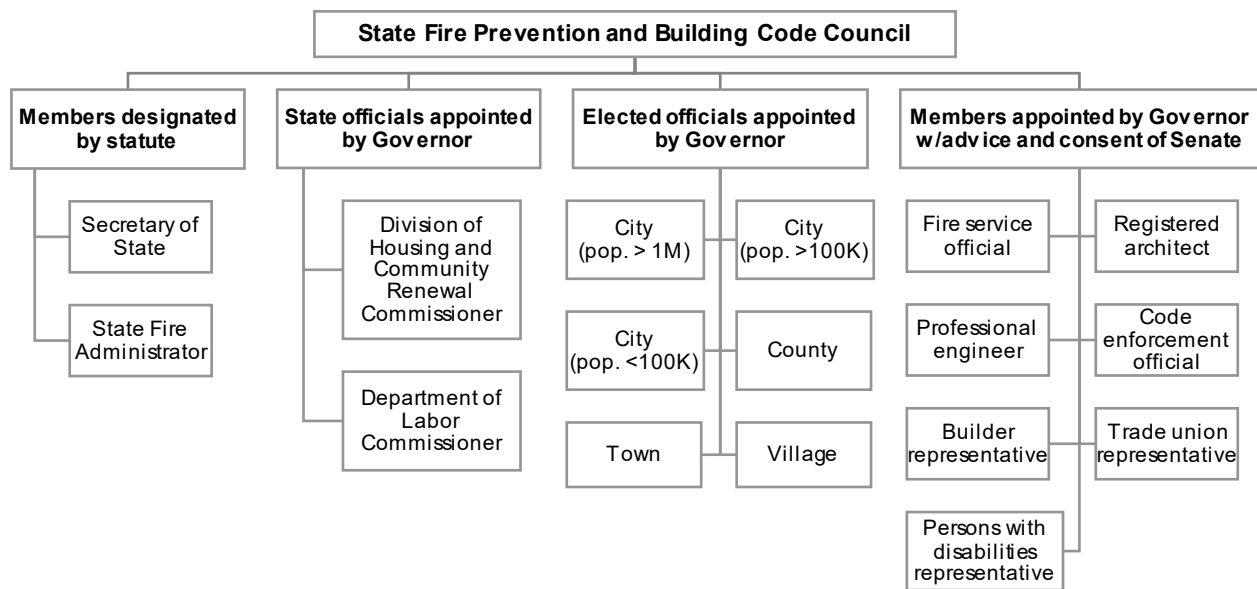

¹² <https://bcapcodes.org/topics/development/>

The NYS Code Council’s 17 members (Figure 3) are appointed by the governor and represent architects, engineers, builders, trade unions, persons with disabilities, code enforcement, fire prevention, villages, towns, cities, counties, State agencies, the State Fire Administrator, and the Secretary of State. A quorum of nine members must be present to adopt proposed code changes.

Prior to adopting changes, the council must submit a notice of proposed rulemaking to the Secretary of State so that it can be published in the State register. Generally, this notice should be made public at least 45 days prior to any council meetings.¹³ The NYS Code Council posts regular notices of proposed rulemakings and allocates a portion of most meetings for public comments. Written comments are also accepted.

After the council votes on a final draft, a notice of adoption is posted in the state register. Figure 4 shows the notice of adoption for the ECCCNYS-2016, posted on April 6, 2016. The full notice includes impact statements, a summary assessment of public comments, and a schedule of the new code’s implementation.

Figure 4. Notice of adoption for the ECCCNYS-2016

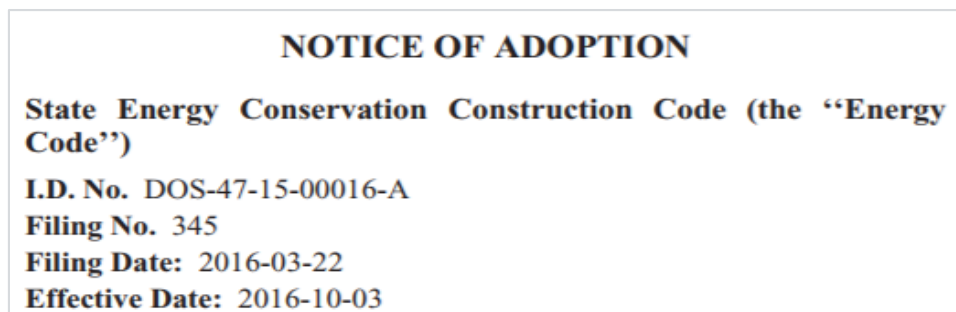

With the adoption of the ECCCNYS-2016, New York became the sixth state with mandatory energy code requirements meeting or exceeding the 2015 IECC and ASHRAE 90.1-2013.¹⁴ New York also allows for local innovation, permitting municipalities to go beyond the State Energy Code by adopting strengthening amendments locally. Overall, New York is a national leader in energy code adoption, compliance, and enforcement.

¹³ <http://codes.findlaw.com/ny/state-administrative-procedure-act/sap-sect-202.html>

¹⁴ <https://www.usgbc.org/articles/implementing-new-energy-code-new-york-state-usgbc-new-york-upstate>

2.3 Compliance

During most new construction or renovation projects, a licensed design professional signs drawings and specifications, indicating the project has been designed in compliance with applicable codes. Although the State sets minimum code requirements, it is generally up to local government to administer and enforce the code.¹⁵ It is then the responsibility of code officials, also commonly known as code enforcement officials, to approve permit applications and project documents and conduct site inspections.

There are approximately 5,000 certified full- and part-time code officials in the State. New York has some of the most rigorous certification requirements for code officials in the country, including attending six basic training courses and completing 24 hours of in-service training annually. Out of 356 code enforcement professionals, most code enforcement officials rank their knowledge of residential and commercial energy code requirements as medium/competent. For residential energy code requirements, 15% rank their knowledge of residential energy code requirements as low/beginner; and for commercial energy code requirements, 20% rank their knowledge as “low/beginner.” Only a minority of State municipal building departments have energy code plan reviewers and inspectors with specialized training. These building departments tend to be in larger cities with a greater number of full-time employees.

These findings support the need to continually educate the design community on code compliance practices. Design professionals need to be partners with the code enforcement officials in the quest for buildings operating in a code-compliant manner.

2.4 Benefits and Challenges of Compliance

Within the family of building codes, energy codes are sometimes viewed as less important than those pertaining to immediate human health, safety, and welfare (HSW) issues. Energy codes lower utility bills for homes and businesses, improve occupant comfort, and significantly reduce the carbon emissions produced by the built environment; thus, providing benefits to both the building occupants as well as the community.

¹⁵ 16

https://www.energycodes.gov/sites/default/files/documents/BECP_Building%20Energy%20Codes%20Resource%20Guide%20Commercial%20Buildings%20for%20Architects_October2010_v00_lores.pdf

Design professionals sometimes find the dense material of code books to be unclear and difficult to parse. As a result, energy codes can be perceived as just another hindrance to getting a project approved for construction. Because of this opinion, energy codes are not commonly integrated into the early design phases and not used to make decisions during these phases. However, code compliance is aligned with other energy efficiency goals, such as LEED accreditation and lower costs of operation. A building that meets code is not just a better building; it is a building that is well on its way to meeting criteria for many voluntary incentives. Integrating energy code reference and using this manual as a design resource early in the process, will help exemplify the benefits of code compliance.

2.5 Legal and Ethical Obligations of Professional Licensure

Architects and engineers bear tremendous responsibility as they are tasked with delivering designs that are aesthetically appealing, safe, and functional. Increased awareness of the environmental impact of buildings has broadened these responsibilities. Architects are bound by the requirements of their licensure to comply with all applicable codes.¹⁶

The nature of the design and construction industry allows owners to make many decisions affecting design, sometimes making it difficult for designers to ensure that energy efficiency is prioritized in the final building. Building energy codes are one way for design professionals to take greater responsibility for the impact of the buildings they design. Code compliance is a mandatory requirement for buildings; by fulfilling their professional duties, architects and engineers can take ownership of building performance.

¹⁶ https://www.energycodes.gov/sites/default/files/documents/BECP_Building%20Energy%20Codes%20Resource%20Guide%20Commercial%20Buildings%20for%20Architects_October2010_v00_lores.pdf

3 Where to Start?

3.1 Chapters of the Energy Code

IECC – Commercial Provisions	IECC – Residential Provisions
Chapter 1 – Scope and Administration	Chapter 1 – Scope and Administration
Chapter 2 – Definitions	Chapter 2 – Definitions
Chapter 3 – General Requirements	Chapter 3 – General Requirements
Chapter 4 – Commercial Energy Efficiency	Chapter 4 – Residential Energy Efficiency
Chapter 5 – Existing Buildings	Chapter 5 – Existing Buildings
Chapter 6 – Referenced Standards	Chapter 6 – Referenced Standards
	Appendix RA – Recommended Procedure for Worst-Case Testing of Atmospheric Venting Systems
	Appendix RB – Solar-Ready Provisions – Detached One- and Two-Family Dwellings, Multiple Single-Family Dwellings (Townhouses)
Index	Index

3.2 What is Covered by the Energy Code?

- Standards for insulation in the walls, basement, attic, and floors
- Energy-efficient windows
- Standards for ventilation and air tightness throughout a building
- Requirements to seal and/or insulate ductwork
- Requirement to install a programmable thermostat
- Requirements for energy-efficient lighting
- Heating, ventilating, and cooling systems and equipment
- Water-heating systems and equipment

3.3 How to Use the Energy Code

Figure 5 shows the four major steps for code compliance. Each step is detailed in the following subsections.

Figure 5. Major steps towards energy code compliance

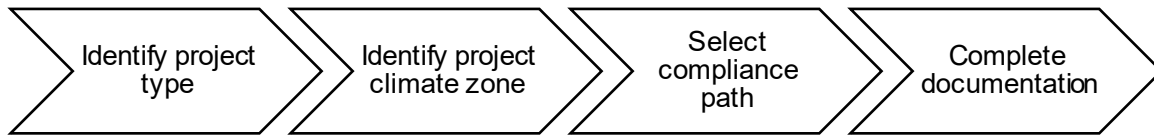

3.3.1 Identify Project Type



3.3.2 Residential or Commercial?

Residential buildings include detached one- and two-family dwellings and townhouses, as well as group R-2, R-3, and R-4 buildings that are three stories or less in height above grade.

New York expands the scope of that definition:

The term “residential building” includes:

- 1. Detached one-family dwellings having not more than three stories above grade plane*
- 2. Detached two-family dwellings having not more than three stories above grade plane*
- 3. Buildings that (i) consist of three or more attached townhouse units and (ii) have not more than three stories above grade plane*
- 4. Buildings that (i) are classified in accordance with chapter 3 of the 2015 international building code (as amended) in group R-2, R-3 or R-4 and (ii) have not more than three stories above grade plane*
- 5. Factory manufactured homes (as defined in section 372(8) of the executive law)*
- 6. Mobile homes (as defined in section 372(13) of the executive law)*

The definitions of residential occupancy classifications are as follows:

Group R-1: Residential occupancies containing sleeping units where the occupants are primarily transient in nature

Group R-2: Residential occupancies containing sleeping units or more than two dwelling units where the occupants are primarily permanent in nature

Group R-3: Residential occupancies where the occupants are primarily permanent in nature and not classified as Group R-1, R-2, R-4 or I

Group R-4: Residential occupancies shall include buildings arranged for occupancy as residential care/assisted living facilities including more than five but not more than 16 occupants

For the ECCCNY-2016, commercial buildings can be defined as all buildings that are not covered under the definition of residential buildings.

In general, the Energy Code defines a commercial building as four stories or more above grade. However, Residential Group R-1 occupancy buildings (hotel, motel, and other transient living facilities) as defined by the IBC are classified commercial in the Energy Code, regardless of the number of stories above grade.

3.3.3 New Construction or Existing Building?

One common misconception is that the Energy Code applies only to new construction. However, Energy Code compliance is also required for renovations and additions in existing buildings. A notable exception is that no code provisions are mandatory for historic buildings as defined in Chapter 2 of the ECCCNY-2016. In all other existing buildings, assuming no building components are hazardous or unsafe for occupants, only those portions of the building affected by the permitted construction (addition, alteration, repairs, or change of occupancy) must be brought up to the current Energy Code requirements.

In a departure from previous code editions, existing building provisions are in their own separate chapters in the commercial and residential sections of the ECCCNY.

3.3.4 Identify Project Climate Zone

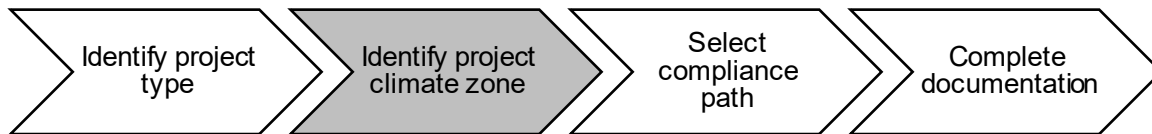

Specific code provisions are based on the project’s location and climate zone. Examples of these location-dependent provisions are envelope requirements, such as window U-factors and wall R-values. Other climate zone dependent provisions include requirements for Energy Recovery Ventilation (ERV) systems, HVAC controls, duct insulation, and economizers. The three climate zones in the State cover all new and existing commercial and residential projects.

All of New York State’s 62 counties, as shown in Figure 6, are Category A (moist). The Energy Code defines moist regions as “locations that are not marine and not dry.”

Figure 6. New York climate zone map

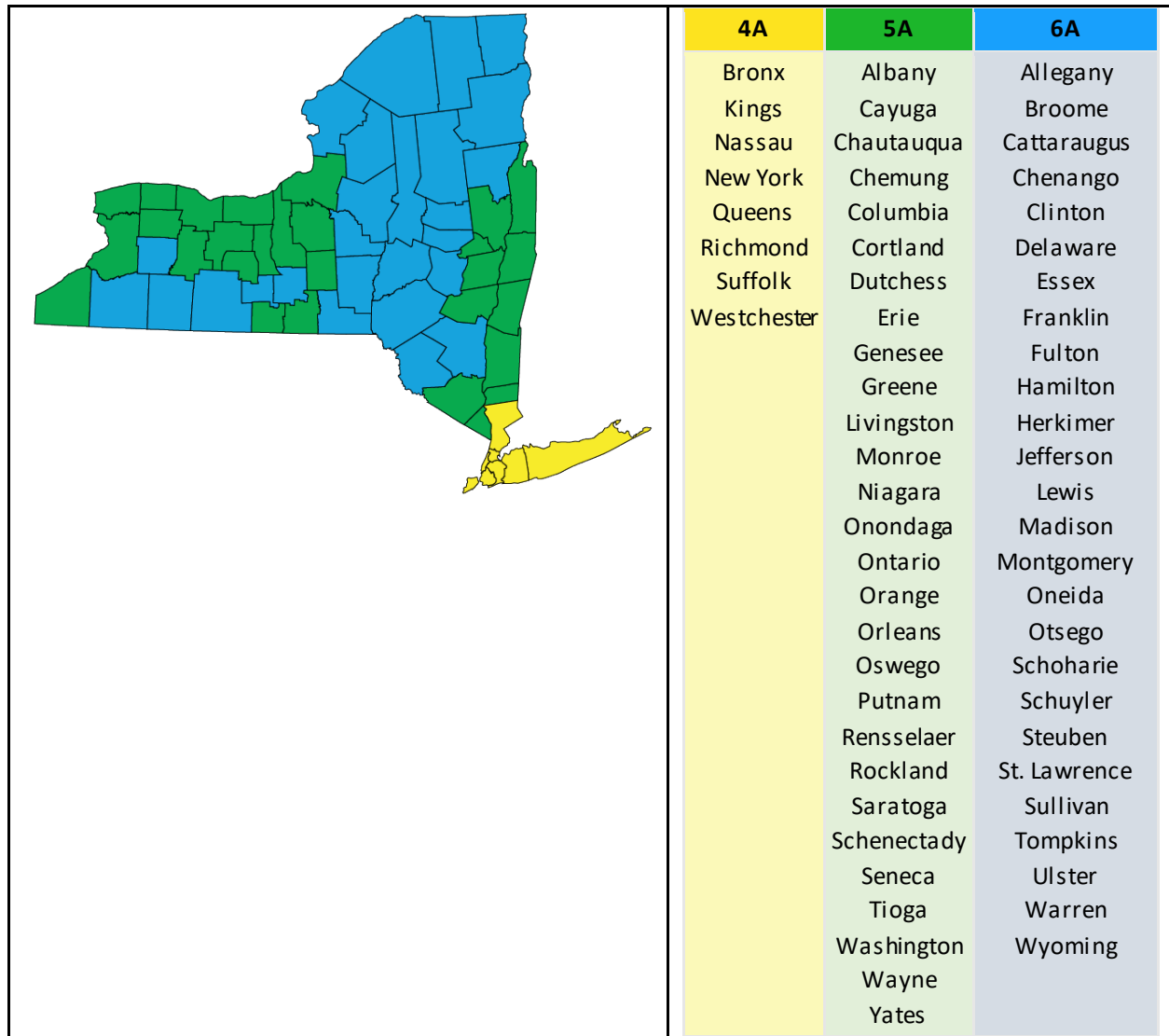

3.3.5 Select Compliance Path



There are two basic energy code compliance paths for both commercial and residential buildings: prescriptive (including REScheck™ or COMcheck™) and performance (including ERI). The most common method of code compliance is the prescriptive approach, in which the code stipulates the stringency of the materials and equipment the designer must use. For the performance approach, the code allocates a total allowable energy use for proposed building, and the design team can choose the materials and equipment that will not exceed this target. For both commercial and residential buildings, compliance with the performance path is shown through energy modeling software.

Figure 7 shows the ECCCNY-2016 compliance paths available for commercial and residential projects. Section C401 of the ECCCNY-2016 allows commercial buildings to show compliance using ASHRAE 90.1-2013 by reference. ASHRAE 90.1-2013 has its own compliance path options: prescriptive, COMcheck™, and performance.

Figure 7. ECCCNY-2016 compliance path options

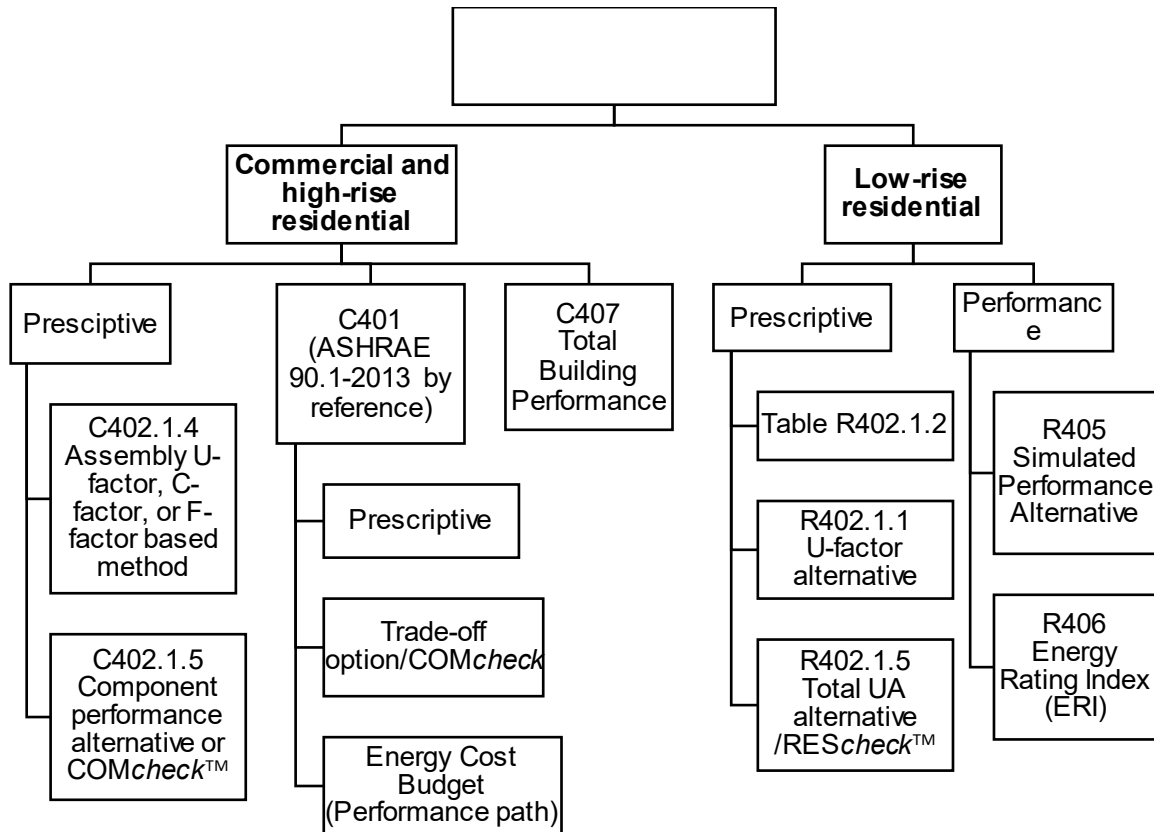

3.3.6 Prescriptive Path

The prescriptive path is a comprehensive checklist of the building components whose characteristics can affect energy consumption. For example, insulation must have certain minimal thermal properties depending on the climate zone of the proposed building site.

The prescriptive path contains a trade-off method that allows some flexibility in envelope R-values and U-factors by allowing trade-offs within (not between) envelope components. In states including New

York, compliance software applications such as REScheck™ and COMcheck™ may be used to demonstrate compliance. Figure 8 illustrates a typical COMcheck™ building envelope example showing where designers can enter component information.

Figure 8. Screen capture from COMcheck™ software

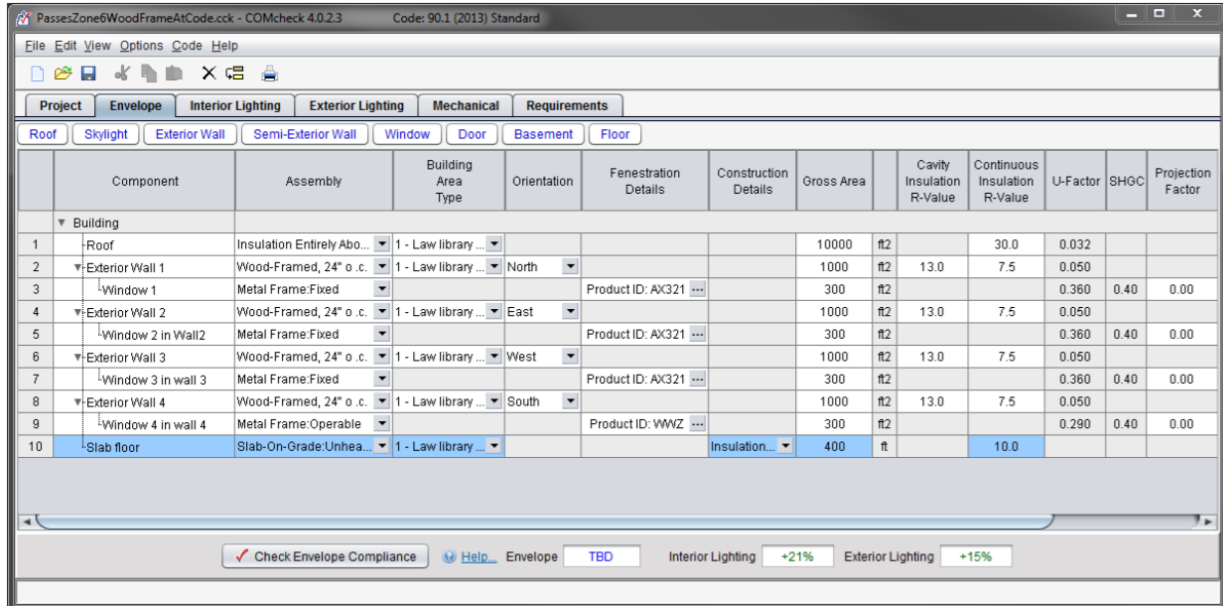

Over the course of history, prescriptive energy codes have proven effective at reducing the amount of energy that code-compliant buildings consume. The prescriptive path remains a logical choice for many residential and small-scale commercial projects.

Prescriptive path	
Advantages	Disadvantages
<ul style="list-style-type: none"> • Straightforward to understand and use • Can show compliance using free REScheck™ or COMcheck™ software, which uses project inputs to generate reports that can be easily printed to show local building department 	<ul style="list-style-type: none"> • Somewhat inflexible, can constrain designs • Can be slow to include provisions on new energy efficiency technology • Cannot accurately evaluate relationships between building components (e.g., building envelope and mechanical systems)

3.3.7 Performance Path

The performance path is an attractive option for design teams working on large or complex projects and those looking to include innovative energy efficiency features whose impact on performance cannot be documented using the prescriptive path. The performance path, as detailed in Section C407 (Total Building Performance), requires commercial projects to meet the following requirements:

The requirements of Sections C402.5, C403.2, C404, C405.2, C405.3, C405.5, C405.6, and C407. The building energy cost shall be equal to or less than 85% of the standard reference design building.

ASHRAE 90.1-2013 has its own performance path for code compliance. Requirements for this path, known as the Energy Cost Budget (ECB) method, are detailed in ASHRAE 90.1-2013 Chapter 11. The ECB should not be confused with the Performance Rating Method (PRM), an ASHRAE appendix intended to evaluate beyond-code building performance. There are plans to include the PRM as another performance-based code compliance option in future editions of ASHRAE 90.1.

The performance path uses approved energy modeling software to calculate annual energy consumption and costs. Instead of setting minimum standards for individual building components, the performance path requires an overall proposed design with an annual energy cost equivalent to (or less than) 85% of the standard reference design building, i.e., one built to comply with the requirements of the prescriptive code. Energy modeling software is also required for showing compliance with Leadership in Energy and Environmental Design (LEED), Energy Star®, and many other incentive-based beyond code programs.

As a best practice, project teams that select the performance path should also use energy modeling software as a tool during the earliest phases of design. During the conceptual and schematic design phases, they can then identify the largest potential sources of building energy consumption and make collaborative decisions about energy efficiency goals and metrics. Modeling software also encourages multiple schematic iterations, allowing teams to quickly visualize the effect of a single component on overall building performance.¹⁷

The Energy Rating Index (ERI), which considers whole-house energy consumption, is becoming a popular performance path option for residential buildings. Section R406 discusses the ERI compliance alternative.

Performance path	
Advantages	Disadvantages
<ul style="list-style-type: none"> • Allows for greater flexibility and creativity • Relative costs of multiple energy-saving design decisions can be easily compared • Gives clients and other stakeholders a better idea of a project's likely operating costs 	<ul style="list-style-type: none"> • Requires use of energy modeling software (e.g., Energy Gauge or REMrate), which requires a modeler trained to use this specialized software • Energy modeling can add considerable cost

¹⁷ <http://bcapcodes.org/compliance-portal/design/energy-modeling/>

3.3.8 Complete Documentation



The construction documents must represent the entire project, including the building thermal envelope, HVAC, service water heating, and lighting and electrical power systems. A code official must review the applicable construction documents and approve them by stamping them as “Reviewed for Code Compliance.” One copy of these approved documents is returned to the applicant, while the other is kept on file by the code official. During building inspections, the official will make sure that the built design is identical to what was indicated in the approved construction documents.

More information on this topic is included in Urban Green Council’s *Conquer the Code* (updated December 2016).

3.4 Overview of Major ECCCNY-2016 Changes

1. Higher R-value requirements for commercial exterior assemblies and other envelope components – Section C402
2. Additional Efficiency Package Options – Section C406
3. New compliance path for residential buildings: Energy Rating Index (ERI) – Section R406
4. Mandatory residential air leakage testing¹⁸ – Section R402.4
5. Enhanced commissioning requirements – Section 408
6. Enhanced residential high-efficacy lighting requirements¹⁹ – Section R404
7. New residential and commercial sections for existing buildings – Chapters C5 and R5

3.5 NYC/NYS Code Differences

This section is included in Urban Green Council’s *Conquer the Code* (updated December 2016).

¹⁸ <http://www.swinter.com/party-walls/tag/energy-code/>

¹⁹ <http://urbangreencouncil.org/content/news/new-energy-code-means-big-efficiency-gains-city-and-state>

4 Commercial Energy Efficiency

4.1 Introduction

C101.2 Scope. The 2015 IECC Commercial Provisions (as amended) apply to commercial buildings, the sites on which commercial buildings are located, and building systems and equipment in commercial buildings.

4.2 Definitions

Building commissioning	A process that verifies and documents that the selected building systems have been designed, installed, and function according to the owner’s project requirements and construction documents, and to minimum code requirements.
Commercial building	Includes all buildings that are not included in the definition of “residential building.”
Demand control ventilation	A ventilation system capability that provides for the automatic reduction of outdoor air intake below design rates when the actual occupancy of spaces served by the system is less than design occupancy.
Economizer, air	A duct and damper arrangement and automatic control system that allows a cooling system to supply outside air to reduce or eliminate the need for mechanical cooling during mild or cold weather.
Economizer, water	A system where the supply air of a cooling system is cooled indirectly with water that is itself cooled by heat or mass transfer to the environment without the use of mechanical cooling.
Entrance door	Fenestration products used for ingress, egress, and access in nonresidential buildings, including, but not limited to, exterior entrances that utilize latching hardware and automatic closers and contain over 50% glass specifically designed to withstand heavy use and possibly abuse.
Opaque door	A door that is not less than 50% opaque in surface area.
Wall, above grade	A wall associated with the building thermal envelope that is more than 15% above grade and is on the exterior of the building or any wall that is associated with the building thermal envelope that is not on the exterior of the building.
Wall, below grade	A wall associated with the basement or first story of the building that is part of the building thermal envelope, is not less than 85% below grade and is on the exterior of the building.
Retro-commissioning	A systematic process to improve an existing building's performance. Using a whole-building systems approach, retro-commissioning seeks to identify operational improvements that will increase occupant comfort and save energy. The process can be performed alone or with a retrofit project.

4.3 Major Commercial Code Changes

1. Higher R-value requirements for exterior assemblies and other building envelope components (Section C402)
2. Additional Efficiency Package Options (Section C406)
3. Enhanced commissioning requirements (Section C408)

More information on these topics is included in Urban Green Council's *Conquer the Code* (updated December 2016).

4.4 Detailed Commercial Code Provisions

C402.2.7 Fireplaces

C402.4.4 Doors

C402.5.1.2.2. Assemblies

C403.2.3.1 Water-cooled centrifugal chilling packages

C403.2.3.2 Positive displacement (air- and water-cooled) chilling packages

C403.2.8 Kitchen exhaust systems

C403.3. Economizers (Prescriptive)

C403.4 Hydronic and multiple-zone HVAC controls and equipment (Prescriptive)

C403.5 Refrigeration systems

C404.8 Drain water heat recovery units

C404.9 Energy consumption of pools and permanent spas (Mandatory)

C404.10 Energy consumption of portable spas (Mandatory)

C405.3 Exit signs (Mandatory)

C504 Repairs

C505 Change of occupancy or use

C402.2.7 Fireplaces

<p><i>New wood-burning fireplaces designed to allow an open burn and new wood-burning fireplace units designed to allow an open burn shall have tight-fitting flue dampers or tight-fitting doors. Tight-fitting doors used on a factory-built fireplace listed and labeled in accordance with UL 127 or on a factory-built fireplace unit listed and labeled in accordance with UL 127 shall be tested and listed for such fireplace or fireplace unit. Tight-fitting doors used on a masonry fireplace shall be listed and labeled in accordance with UL 907.</i></p> <p><i>New wood-burning fireplaces designed to allow an open burn and new wood-burning fireplace units that are designed to allow an open burn shall be provided with a source of outdoor combustion air as required by the fireplace construction provisions of the 2015 International Building Code (as amended), the 2015 International Residential Code (as amended) or the New York City Construction Codes, as applicable.</i></p>	
<p>New or modified information from ECCCNY-2014</p>	<p>Modified</p>
<p>Interpretation and intent</p>	<p>There are three main types of fireplaces: natural-draft, mechanically drafted, and direct-vent sealed-combustion. Natural-draft and mechanically drafted fireplaces take at least some of their combustion air from the indoor space. The wood-burning fireplaces and fireplace units discussed in this section are natural-draft.</p> <p>Factory-built fireplaces, as the name suggests, are built in a factory setting and assembled in the field in accordance with manufacturer's instructions and site conditions. Masonry fireplaces are constructed on site and composed of solid masonry units, bricks, stones, or concrete.</p> <p>Tight-fitting flue dampers or doors reduce heat loss. A source of outdoor combustion air reduces the amount of conditioned air that a fireplace will pull from inside the building. This ensures that the fireplace or fireplace unit will function properly and safely without back-drafting.</p> <p>Construction documents should include fireplace door specifications and exterior air supply specifications.²⁰</p>

²⁰ <https://basc.pnnl.gov/code-compliance/fireplaces-proper-ventilation-new-wood-burning-fireplaces-code-compliance-brief>

Figure 9. Tight-fitting door requirements for natural-draft fireplaces

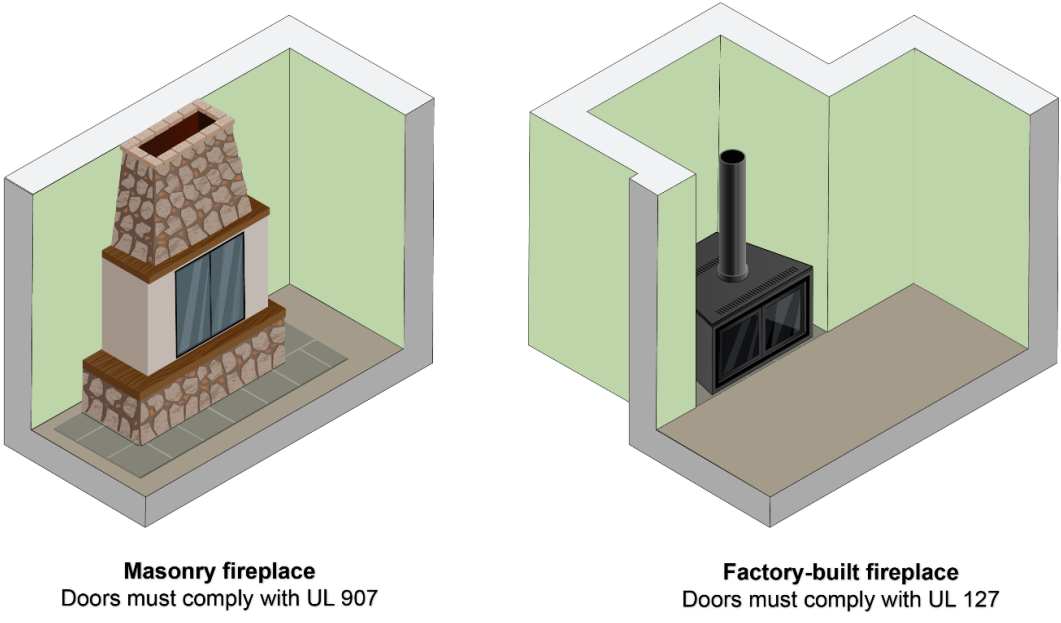
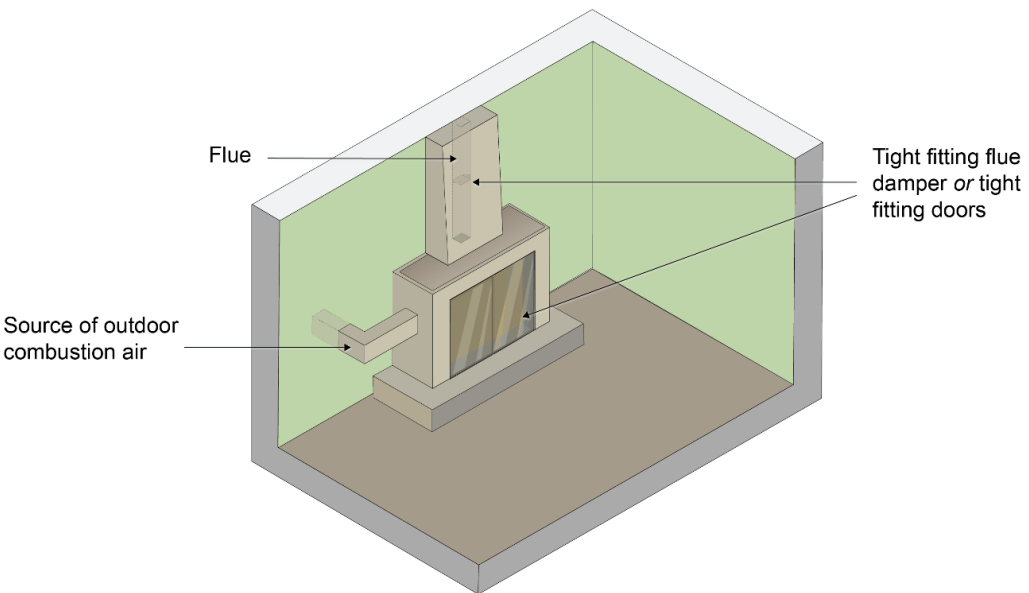

Figure 10. Requirements for certain new wood-burning fireplaces and fireplace units



<p>Best practices</p>	<p>Inform building owners that fireplace doors and/or flues should be closed whenever the unit is not in use to reduce unwanted airflow.</p>
<p>Common pitfalls</p>	<p>With the increased air tightness requirements of the ECCCNY-2016, natural-draft fireplaces are susceptible to back-drafting, which can occur when the fireplace pulls an excessive amount of combustion air from inside the building. Back-drafting can also happen when another appliance, such as a bathroom fan, pulls combustion air and pollutants from the fireplace into the building.</p>

C402.4.4 Doors

<p><i>Opaque doors shall comply with the applicable requirements for doors as specified in Tables C402.1.3 and C402.1.4 and be considered part of the gross area of above-grade walls that are part of the building thermal envelope. Other doors shall comply with the provisions of Section C402.4.3 for vertical fenestration.</i></p>	
<p>New or modified information from ECCCNY-2014</p>	<p>Modified</p>
<p>Interpretation and Intent</p>	<p>Opaque doors, divided in the Energy Code into non-swinging and swinging, are doors with less than 50% glazing area. Types of non-swinging doors include sliding and roll-up doors. In addition to C402.4.4, garage doors should also meet the air leakage requirements in Table C402.5.2.</p> <p>Opaque doors do not count towards the total fenestration area when calculating compliance with the vertical fenestration requirements in Section C402.4.1.</p>
<p>Figure 11. Varieties of commercial doors</p>	
<p>Best practices</p>	<p>Make sure to rebalance HVAC systems when installing energy-efficient windows and doors in existing structures. When new energy-efficient windows and doors are installed in existing buildings, the HVAC system should be rebalanced to accommodate the reduced levels of air infiltration through the windows and doors.</p>
<p>Common pitfalls</p>	<p>Not rebalancing: negative pressures can be created within the building because the HVAC unit is still trying to draw make-up air from the existing spaces, yet there is less volume allowed from around the windows and doors. When the allowable air infiltration is reduced in volume, a higher pressure (negative) is created within the structure. That make-up air must come from someplace else, typically from other small holes or cracks in the building envelope.</p> <p>Other issues with doors include heat loss from air movement during operation, heat loss from air movement through the perimeter detail, and radiant heat loss through the door materials themselves. Door frames that do not incorporate a adequate thermal isolation form thermal bridges that tend to lead to wintertime condensation.²¹</p>

²¹ <https://www.wbdg.org/systems-specifications/building-envelope-design-guide/fenestration-systems/exterior-doors#intro>

C402.5.1.2.2 Assemblies

Assemblies of materials and components with an average air leakage not greater than 0.04 cfm/ft² under a pressure differential of 0.3 inch of water gauge (w.g.) when tested in accordance with ASTM E2357, ASTM E1677, or ASTM E283 shall comply with this section. Assemblies listed in items 1 through 3 shall be deemed to comply, provided joints are sealed and the requirements of Section C402.5.1.1 are met.

1. Concrete masonry walls coated with either one application of block filler or two applications of a paint or sealer coating
2. Masonry walls constructed of clay or shale masonry units with a nominal width of four inches or more
3. A Portland cement/sand parge, stucco, or plaster not less than 1/2 inch in thickness

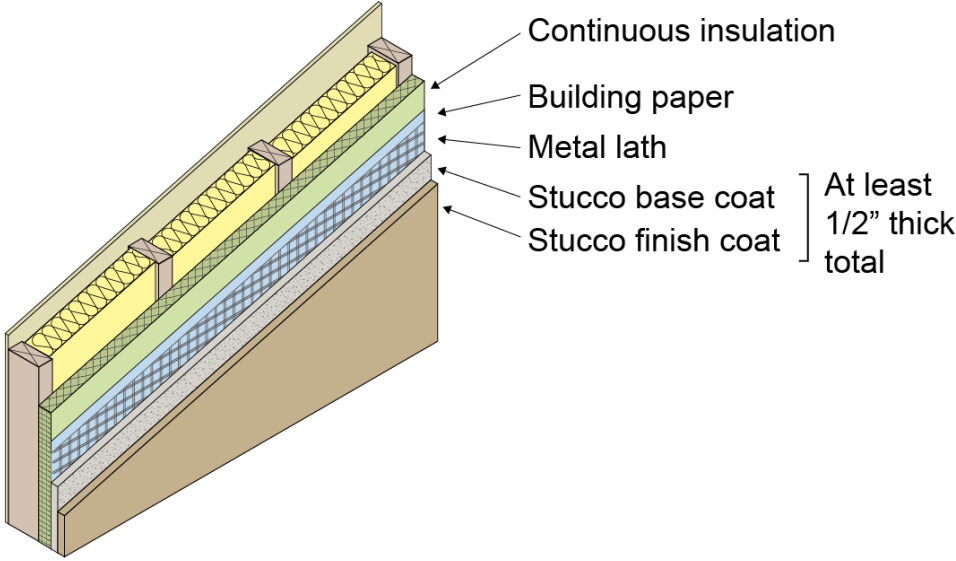
New or modified information from ECCCNY-2014	Modified
Interpretation and Intent	<p>Section C402.5.1.2 states that the continuous air barrier of an opaque building envelope must comply with either Section C402.5.1.2.1 (relating to material selection) or Section C402.5.1.2.2 (relating to assembly selection).</p> <p>More information on this topic is included in Urban Green Council's <i>Conquer the Code</i> (updated December 2016).</p> <p>The ECCCNY-2016 details three assembly types that are deemed to comply with the air barrier requirements. Assemblies, such as the one shown in Figure 12, must be tested to conform to applicable ASTM standards.</p> <p>Figure 12. A code compliant stucco wall assembly</p> 
Best practices	<p>External assembly components should incorporate water-shedding surfaces. Flashing details at intersecting materials, building wrap, and a rigid-insulation thermal barrier will also help prevent unintended moisture from entering the building envelope.</p>

Common pitfalls	<p>Common pitfalls in assemblies include the following:</p> <ul style="list-style-type: none"> • Infiltration: The introduction of unconditioned air into the conditioned, interior spaces of a building or structure due to voids in the enclosure system. • Exfiltration: The loss of conditioned air from a building or structure due to voids in the enclosure system, and/or the introduction of conditioned air into unconditioned spaces of an exterior wall assembly. • Mixing: The process by which unconditioned air and conditioned meet, and mix, within an exterior wall assembly. Depending upon the air temperature and relative humidity in the cavity space at the time that mixing occurs, condensation may form on the colder elements located in the dry zone of the wall assembly (such as metal studs during the summer cooling season).²²
-----------------	--

Background on air- and water-cooled chilling packages

In many commercial facilities, space cooling and process cooling applications are two of the largest energy expenditures. To meet these needs, large projects utilize complex HVAC systems, typically including one or more chillers that provide air conditioning by using water to remove heat from indoor spaces. In addition to chillers, a typical HVAC system includes pumps and other ancillary equipment.

Selecting an appropriate chiller can be one of the most important decisions for a project's mechanical engineers. If a project uses components from different manufacturers, calculations and supporting data should demonstrate that the combined efficiency meets code requirements.

Energy-efficient chillers can underperform because of excess pump and fan energy caused by bad selection, poor control, small pipes and ducts, and other design issues. Being aware of system energy performance under likely operating conditions is far more important than selecting the most efficient equipment.²³

This section provides background on the two main types of traditional vapor-compression chillers: air- and water-cooled. Efficiencies for water-cooled units are generally higher than those for air-cooled, a result of more efficient heat transfer and therefore lower condensing temperatures.²⁴ Most large commercial buildings use water-cooled chillers.²⁵

²² <https://www.wbdg.org/systems-specifications/building-envelope-design-guide/wall-systems>

²³ <https://buildingscience.com/documents/digests/bsd-200-low-energy-commercial-institutional-buildings-top-ten-smart-things-to-do-cold-climates>

²⁴ <http://www.energydepot.com/rpucm/library/hvac013.asp>

²⁵ <https://energy.gov/sites/prod/files/2017/03/f34/qtr-2015-chapter5.pdf>



Vapor-compression chiller advantages by subtype	
Air-cooled	Water-cooled
	
<ul style="list-style-type: none"> • Lower installation and maintenance costs • Faster equipment availability • No cooling tower, condenser pumps, or mechanical room required 	<ul style="list-style-type: none"> • Lower operating costs • Longer lifespan • Wider equipment selection • Allows for redundancies • Larger tonnage capabilities

Figure 13. Types of chillers



The main vapor-compressor chiller compressor types are centrifugal and positive displacement. The latter can be subdivided into reciprocating, screw, and scroll:

1. Reciprocating compressors use cylinders with pistons acting as pumps to increase refrigerant pressure.
2. Screw compressors compress gas by direct volume reduction between rotating screws. Screw compressors are available in several designs, including single screw or twin screw.
3. Scroll compressors use a stationary scroll within a rotating scroll to compress refrigerant.²⁶ Multiple scroll compressors are often used in a single chiller to meet larger capacities.²⁷

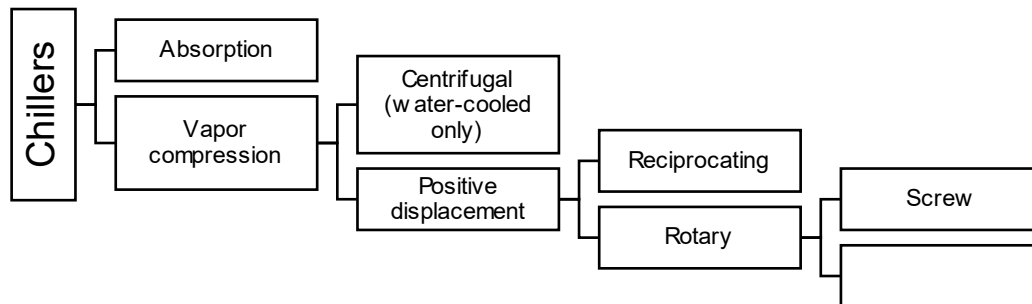
²⁶ <https://www.epa.gov/snap/chillers>

²⁷ <http://www.ahrinet.org/contractors.aspx?S=134>

Figure 14. Example of a complex commercial HVAC system with chiller

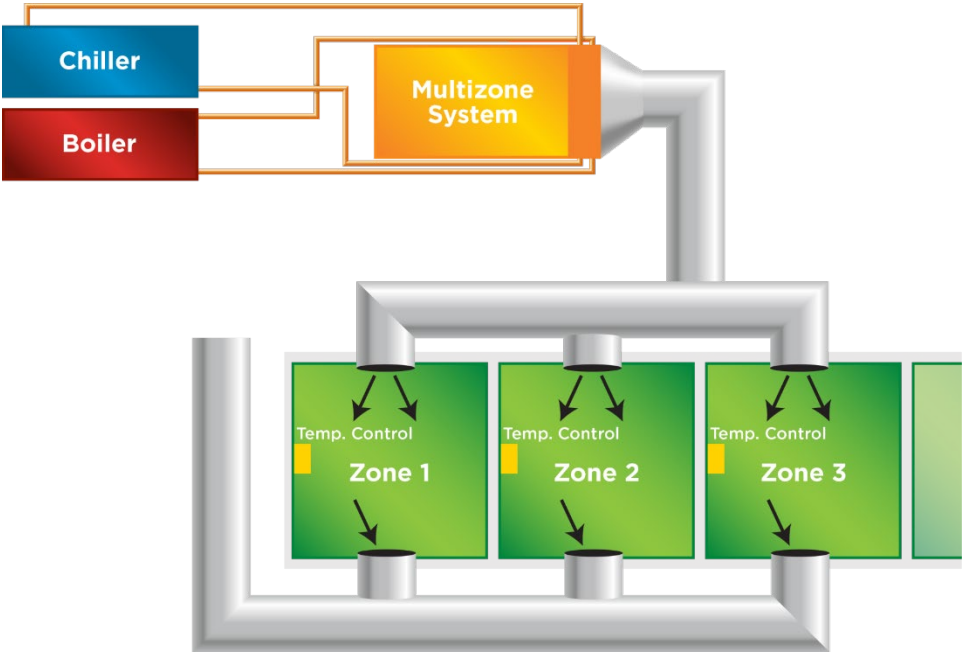

C403.2.3.1 Water-Cooled Centrifugal Chilling Packages

Equipment not designed for operation at AHRI Standard 550/590 test conditions of 44°F (7°C) leaving chilled-water temperature and 2.4 gpm/ton evaporator fluid flow and 85°F (29°C) entering condenser water temperature with 3 gpm/ton (0.054 l/s • kW) condenser water flow shall have maximum full-load kW/ton (FL) and part-load ratings requirements adjusted using equations 4-6 and 4-7.

New or modified information from ECCCNY-2014

Modified

Figure 15. AHRI 550/590 test conditions for water-cooled centrifugal chilling packages

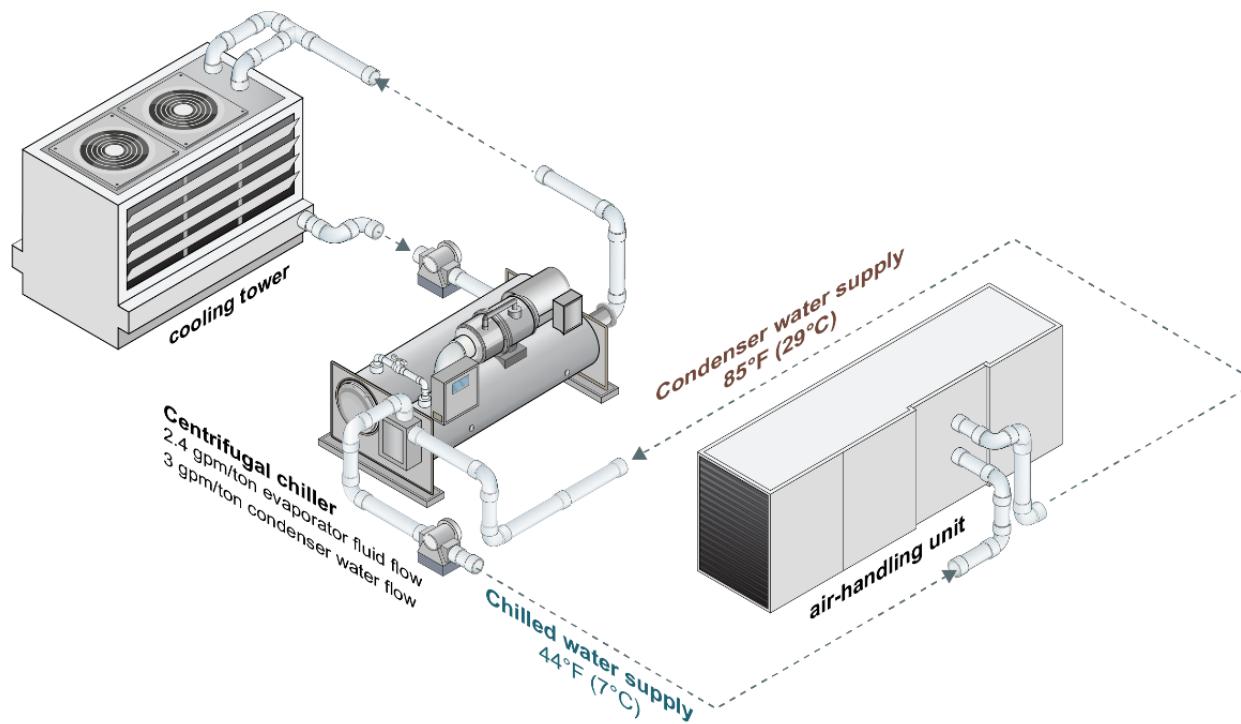

Interpretation and Intent

In a water-cooled centrifugal chilling package, water travels through two loops: one that supplies chilled water to the facility from the evaporator, then brings that water back to the chiller at a higher temperature after it has removed heat from the facility. During this first loop, the chilled water is pumped through the cooling coil of air-handling units (as shown in Figure 14). As the chiller removes heat from this returning, warmed water, it rejects this heat via a second condenser water loop and cooling tower.

To comply with the Energy Code, chilling packages must be designed according to the AHRI 550/590 test conditions shown in Figure 15. This information should be available from the manufacturer.

If the package was not tested according to that standard, the maximum full-load and part-load rating requirements should be adjusted using the equations shown in Section C403.2.3.1. This provision is included to ensure that all chilling packages, regardless of their factory testing conditions, are operating efficiently.

Figure 16. Schematic diagram of a typical rooftop commercial air-handling unit

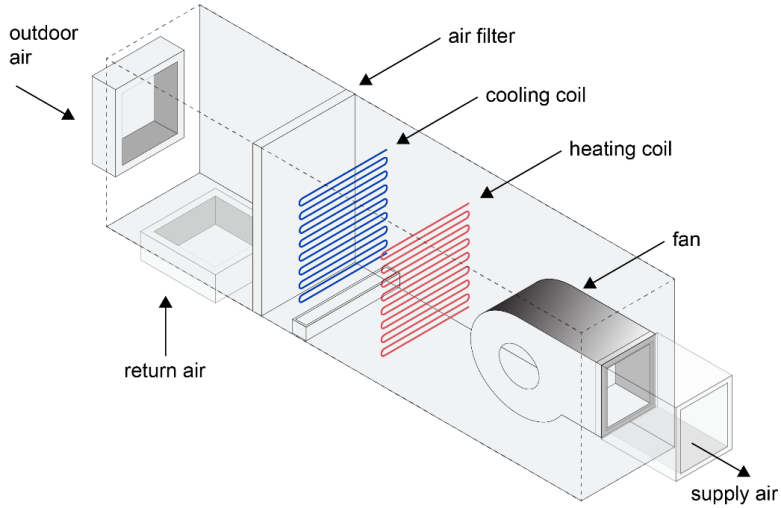
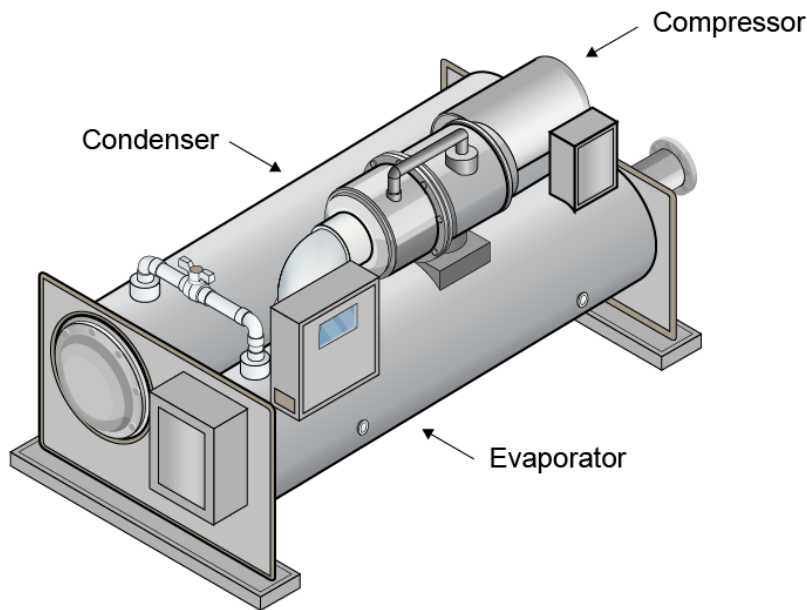

Figure 17. Main components of a water-cooled centrifugal chiller



<p>Best practices</p>	<p>After equipment sizing, there are still a variety of factors to consider when selecting a water-cooled chilling package, including the available footprint in the building’s mechanical room and the upfront versus lifetime costs of the system. Before selecting a chilling package, design teams should consider using software to model building energy loads throughout the year.</p>
<p>Common pitfalls</p>	<p>Account for serviceability when planning space requirements. In general, chillers should have at least three feet of clearance on top and on either side.</p>

C403.2.3.2 Positive displacement (air- and water-cooled) chilling packages

<p><i>Equipment with a leaving fluid temperature higher than 32°F (0°C) and water-cooled positive displacement chilling packages with a condenser leaving fluid temperature below 115°F (46°C) shall meet the requirements of Table C403.2.3(7) when tested or certified with water at standard rating conditions, in accordance with the referenced test procedure.</i></p>	
<p>New or modified information from ECCCNY-2014</p>	<p>Modified</p>
<p>Interpretation and Intent</p>	<p>Positive displacement chillers, both air-cooled and water-cooled, must meet the requirements of Table C403.2.3(7).</p>
<p>Best practices</p>	<p>Fuel availability, efficiency, and compressor type all play roles in a buyers' decisions. While water-cooled centrifugal chillers have historically dominated the chiller market, air-cooled chiller popularity is rising as these systems have become more efficient. Air-cooled chillers do have a higher electrical draw, leading to higher electrical costs, but these expenses can be offset by the pump energy and water costs of the water-cooled system. The latest generation of air-cooled chillers presents an undeniable alternative in the 300- to 1,000-ton range, where larger water-cooled systems once reigned.</p> <p>Air-cooled chillers typically have larger footprints than water-cooled chillers, but they are located on the rooftop, where there is usually space available. Water-cooled chillers require a mechanical room somewhere inside the building and utilize space that could potentially be used for the building's industry. Water-cooled chiller systems also require a cooling tower, condenser pumps, additional components, and a water-treatment strategy. However, because they are located inside, water-cooled chillers are safe from the outside environment and have a longer life span.</p> <p>Overall, water-cooled chillers outperform air-cooled types with regard to efficiency by a wide margin, especially in larger applications.</p>
<p>Common pitfalls</p>	<p><i>Positive displacement (both air- and water-cooled) chillers, with glycol added for freeze protection in cold climates, are likely to use a secondary coolant with a freeze point below 27°F. However, if the positive displacement chiller is designed to create a cooling temperature greater than 32°F, machine changes may hinder its ability to meet the requirements.</i></p>

C403.2.8 Kitchen exhaust systems

Replacement air introduced directly into the exhaust hood cavity shall not be greater than 10 percent of the hood exhaust airflow rate. Conditioned supply air delivered to any space shall not exceed the greater of the following:

- 1. The ventilation rate required to meet the space heating or cooling load.*
- 2. The hood exhaust flow minus the available transfer air from adjacent space where available transfer air is considered that portion of outdoor ventilation air not required to satisfy other exhaust needs, such as restrooms, and not required to maintain pressurization of adjacent spaces.*

Where total kitchen hood exhaust airflow rate is greater than 5,000 cfm, each hood shall be a factory-built commercial exhaust hood listed by a nationally recognized testing laboratory in compliance with UL 710. Each hood shall have a maximum exhaust rate as specified in Table C403.2.8 and shall comply with one of the following:

- 1. Not less than 50% of all replacement air shall be transfer air that would otherwise be exhausted.*
- 2. Demand ventilation systems on not less than 75% of the exhaust air that are capable of not less than a 50% reduction in exhaust and replacement air system airflow rates, including controls necessary to modulate airflow in response to appliance operation and to maintain full capture and containment of smoke, effluent, and combustion products during cooking and idle.*
- 3. Listed energy recovery devices with a sensible heat recovery effectiveness of not less than 40% of the total exhaust airflow.*

Where a single hood, or hood section, is installed over appliances with different duty ratings, the maximum allowable flow rate shall be based on the requirements for the highest appliance duty rating under the hood or hood section.

Exception: Where not less than 75% of all the replacement air is transfer air that would otherwise be exhausted.

<p>New or modified information from ECCCNY-2014</p>	<p>New</p>
<p>Interpretation and Intent</p>	<p>Exhaust air must be mechanically discharged from conditioned space to maintain a adequate indoor air quality. Kitchen exhaust energy is used both to operate fans and to heat and cool makeup air that is then exhausted. Two mandatory requirements apply to all kitchens:</p> <ol style="list-style-type: none"> 1. Makeup air is limited to maximize transfer air. 2. Short-circuit hoods are not allowed. <p>Short-circuit hoods inject more than 10% of unconditioned makeup air directly into the hood</p>

rather than into the space. Recent research found these hoods require higher airflows to effectively contain smoke, increasing overall energy use.²⁸

Figure 18. Commercial kitchen exhaust system

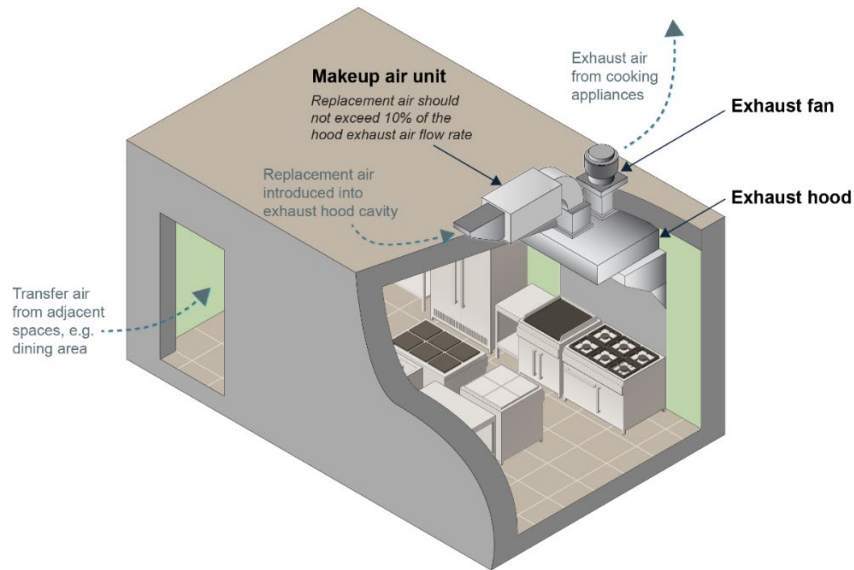

Best practices

Figure 19. Potential air leakage spots in exhaust systems

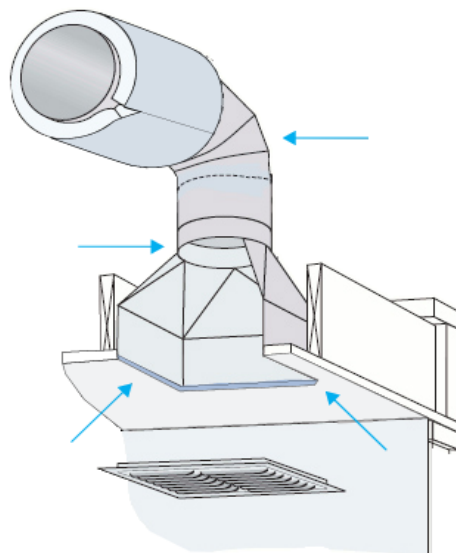

Air seal: As shown in Figure 19, exhaust fans and dampers should be sealed, especially at potential leak points, to prevent uncontrolled air flow between conditioned and unconditioned spaces.

Because exhaust fans can carry warm, moist air, any penetrations should be completely sealed and insulated to prevent condensation, especially if they run through unconditioned space.

Balance: It is critically important to integrate a restaurant's HVAC system with commercial kitchen ventilation to get reliable and efficient operation.

Remember that the "V" in HVAC stands

for ventilation! The heating and cooling system must work hand in hand with kitchen ventilation or the operation of both systems could be compromised. This highlights the importance of kitchen design and HVAC design experts working together. Use an HVAC installer that is experienced with and qualified to do installation design for food service establishments.

Frequently asked questions

Q: What are the makeup air requirements for kitchen exhaust systems? What percentage of fresh air to exhaust air is required?

	A: Section 505.2 in the International Mechanical Code (IMC) requires makeup air for kitchen exhaust hoods more than 400 cfm. The amount of makeup air should be equal to the exhaust air.
Common pitfalls	Smoke and heat must be vented to the outside, either to the roof or possibly through an exterior wall, depending on the application. Do not vent air into a crawl space. The internal vent location must be carefully planned, to avoid locating it too close to a supply vent that can draw the exhaust back into the building.

C403.3 Economizers (Prescriptive)

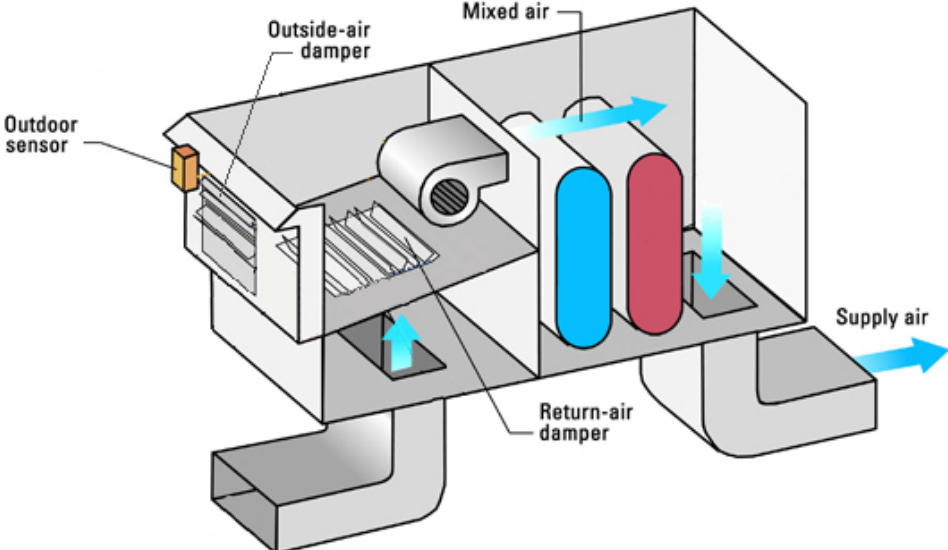
<p><i>Each cooling system shall include either an air or water economizer complying with Sections C403.3.1 through C403.3.4.</i></p>	
<p>New or modified information from ECCCNY-2014</p>	<p>Modified</p>
<p>Interpretation and Intent</p>	<p>Figure 20. Air-side economizer</p>  <p>Generally, in New York, an economizer is required on individual DX cooling units greater than 54,000 BTU/H. Economizers, however, are not required in every application; there are exceptions. For example, economizers are not required in the following situations:</p> <ul style="list-style-type: none"> ■ Systems expected to operate < 20 hours/week. ■ Where > 25% of air designed to be supplied by the system is to spaces that are designed to be humidified. ■ Systems that serve residential spaces where system capacity is < 5 times requirement in Table C403.3.1(1). ■ Where use of outdoor air for cooling will affect supermarket open refrigerated casework systems. ■ Where cooling efficiency meets or exceeds efficiency requirements in Table C403.3(2). Note: this exception applies to systems in Climate Zone 4B meeting or exceeding efficiency requirements by 20%. ■ Air-side economizers introduce outdoor air directly into a space or cool indoor air with outdoor air indirectly using a heat exchanger.

	<p>Many commercial buildings use air conditioning almost year-round. For example, a restaurant produces so much heat that even when it is cold outside, the building may need cooling. An economizer uses the cool air outside to save cooling energy inside. The prescriptive economizer requirements in Section C403.3 include nine exceptions relating to building efficiency, hours of weekly operation, and other design parameters.</p> <p>In a cooling application, an economizer is a mechanical device that uses cool outside air to cool inside a building, reducing space conditioning costs. The economizer control is installed as a part of the ventilation/cooling system. When it senses that outdoor conditions are correct, it shuts off the air conditioner compressor and opens the outside air damper. The fan then draws in outside air to provide cooling. When the control senses that the outside air is unsuitable for cooling, the damper closes, and the air conditioning compressor turns on again.</p>
<p>Best practices</p>	<p>The right installation and maintenance will assure energy and cost savings. Economizers are suitable for facilities of any size and type. Those with mission critical loads, such as data centers, will experience significant benefits, as well as those with year-round cooling needs. Buildings with a high number of internal rooms are also good candidates for a quick payback and return on investment.</p> <p>Retrofitting an economizer doesn't require major structural or mechanical changes. The units are a modest size and should easily fit within an existing HVAC footprint. They are typically added along the outside wall or roof, so the air handling unit's air intake plenum is connected to the outside wall and motorized dampers. Depending on the existing equipment, the economizer can be custom-installed by a contractor or packaged with a new air handling unit. When adding an air-side economizer to an existing HVAC system, plan carefully for a larger outside air intake, a larger relief air opening, potentially a relief air fan, proper damper sizes, and appropriate and reliable controls.</p>
<p>Frequently asked questions</p>	<p>Q: What are the exceptions for economizer requirements? A: The use of economizers is prescriptive and can be traded off if using another compliance approach. Economizers are a prescriptive requirement unless the project's cooling system meets one of the nine requirements listed in Section C403.3.</p> <p>Q: Can I use ASHRAE 90.1-2013 to demonstrate compliance with economizer requirements? A: Yes, but you must then use ASHRAE in its entirety as your path to demonstrate compliance for all building components.</p> <p>Q: What are the economizer requirements for variable refrigerant volume or flow (VRV/VRF) systems? A: VRV and VRF systems are not addressed in the 2015 IECC but are addressed in ASHRAE 90.1-2013 (and ASHRAE 90.1-2016). VRV and VRF systems are also not currently handled within COMcheck™. When they are entered and selected as condensing units they will, on the COMcheck™ report, indicate the requirement for an integrated economizer. These COMcheck™ reports will need to be manually alternated with this redaction requirement and a notation regarding the fact the 2015 IECC does not address the efficiency requirements for these units but that the efficiency meets the requirements of Tables 6.8.1-9 and 6.8.1-10 in ASHRAE 90.1-2016.</p>

Common pitfalls	<p>Because economizers have several continuously moving parts that are exposed to weather conditions, it's critical to specify robust materials that can withstand the climate and time.</p> <p>Good quality, low-leakage dampers are very important. Even though a significant amount of surface area is required to bring in air during the economizer cycle, air should not leak when not in use.</p> <p>Consider bypassing the economizer on days when pollen or smog levels are excessive.</p> <p>If the outdoor air quality is excellent, an economizer will improve indoor air quality as it provides more oxygen to occupants. But if it's poor air quality, there is the potential to be introducing pollutants and allergens at a higher volume than without an economizer. In those cases, increase filtration, which can be difficult in a one-pass system. Don't defer maintenance with an economizer. While by no means a delicate piece of equipment, any number of issues can trigger a chain reaction that ultimately causes the unit to waste energy. The longer inspections and cleaning are ignored, the more issues are likely to occur.</p> <p>Ensure that economizer maintenance is included in the commissioning plan. Many air-side economizers aren't working properly due to lack of maintenance. It's important to regularly test the operation of air-side economizers to ensure long-term performance. Maintenance should include evaluating the economizer and dampers daily. And a full inspection before and after economizer season, or every six months for year-round cooling.²⁹</p>
-----------------	---

²⁹ <https://www.buildings.com/article-details/articleid/18381/title/5-ways-to-maximize-your-economizer-efficiency/viewall/true>

C403.4 Hydronic and Multiple-Zone HVAC Controls and Equipment (Prescriptive)

<i>HVAC system controls and equipment shall comply with this section.</i>	
New or modified information from ECCCNY-2014	Modified
Interpretation and Intent	<p>Systems covered in these sections include:</p> <ul style="list-style-type: none"> • Packaged Variable Air Volume (VAV) • Built-up VAV • Built-up single-fan, dual-duct VAV • Built-up or packaged dual-fan, dual-duct VAV • Four-pipe fan coil system with central plant • Water source heat pump with central plant • Any other multiple-zone system • Hydronic space heating and cooling system <p>Sections C403.4.1 through C403.4.6 below discuss each sub-provision of this section.</p>
Best practices	<p>Two additional efficiency package options (Section C406) apply to mechanical systems. Buildings with hydronic and multiple-zone HVAC systems controls and equipment should consider this option:</p> <p>Provision of a dedicated outdoor air system for certain HVAC equipment in accordance with Section 406.6.</p>
Common pitfalls	<p>Three pipe hydronic systems that use a common return where heated and cooled water is mixed, is essentially prohibited by code.</p>

C403.4.1 Fan control

<p><i>Controls shall be provided for fans in accordance with Sections C403.4.1.1 through C403.4.1.3</i></p>	
<p>New or modified information from ECCCNY-2014</p>	<p>Modified</p>
<p>Interpretation and Intent</p>	<p><i>Fans generally are the largest energy-using components of HVAC systems. HVAC systems generally spend most of their operating hours at part loads, where little or no cooling is required. Few systems require full cooling capacity at all operating hours. Multiple stages of cooling at part-load conditions allow lower fan speed and higher efficiency for direct expansion (DX) cooling. This section sets limits for multiple-stage cooling that align with requirements found in ASHRAE 90.1.</i></p> <p>Each system described in Table C403.4.1.1 (DX Cooling or Chilled Water and evaporative cooling) shall be designed to vary the indoor fan airflow as a function of the load.</p> <p><i>Exceptions:</i></p> <p><i>Modulating fan control is not required for chilled water and evaporative cooling units with fan motors of less than 1 hp where the units are not used to provide ventilation air and indoor fan cycles with the load.</i></p> <p><i>Where the volume of outdoor air required to comply with the ventilation requirements of the IMC at low speed exceeds the air that would be delivered at the speed defined in Section C403.4.1, the minimum speed shall be selected to provide the required ventilation air.</i></p> <p><i>Exception 2 is relative to spaces requiring high outdoor air ventilation rates, such as an assembly occupancy.</i></p>
<p>Best practices</p>	<p>It is commonplace to supply two to three times the minimum airflow required in order to overcome losses from duct leakage and airflow short circuiting. Reducing airflow is one of the most cost-effective means of reducing power demand and energy use. It reduces direct energy use by the fans as well as indirect cooling energy use from reduced fan heat losses.</p>

Common pitfalls	<p>With a constant-speed fan, proper ventilation is achieved by setting the position of the outdoor-air damper during startup and balancing. With a variable speed fan, care needs to be taken to ensure proper ventilation control.</p> <p>To address this issue and ensure proper ventilation in a single-zone VAV system, consider one of the following approaches:</p> <ol style="list-style-type: none"> 1. Two-position outside air (OA) damper control. For a system with two-speed fan control, two position setpoints can be used; Proportional control of OA damper. For a system with variable-speed fan control, one solution could be to modulate the position of the OA damper in proportion to the changing supply fan speed. This is a relatively inexpensive solution, so it is likely to be used in many of the smaller, single-zone VAV applications. <p>Flow-measuring OA damper. Another method for controlling ventilation is to measure the outdoor airflow and control it directly; Dedicated OA delivered directly to each zone. The three previous approaches are suitable for a piece of equipment that has a mixing box and outdoor-air damper—such as a packaged rooftop unit, air-handling unit, or classroom unit ventilator. But most models of fan-coils or water-source heat pumps just have a single inlet opening—no mixing box or outdoor-air damper. Ventilation is typically provided by a dedicated outdoor-air system.³⁰</p>
-----------------	---

³⁰ https://www.trane.com/content/dam/Trane/Commercial/global/products-systems/education-training/engineers-newsletters/standards-codes/adm-apm047-en_0413.pdf

C403.4.2 Hydronic System Controls

<p><i>The heating of fluids that have been previously mechanically cooled and the cooling of fluids that have been previously mechanically heated shall be limited in accordance with Sections C403.4.2.1 through C403.4.2.3. Hydronic heating systems comprised of multiple-packaged boilers and designed to deliver conditioned water or steam into a common distribution system shall include automatic controls capable of sequencing operation of the boilers. Hydronic heating systems comprised of a single boiler and greater than 500,000 Btu/h input design capacity shall include either a multi-staged or modulating burner.</i></p>	
<p>New or modified information from ECCCNY-2014</p>	<p>Modified</p>
<p>Interpretation and Intent</p>	<p><i>This section, in effect, prohibits three-pipe systems that use a common return where heated and cooled water is mixed, requiring energy to bring it back to temperature.</i></p> <p><i>The provisions addressing multiple-packaged boilers and single boilers greater than 500,000 Btu/h input capacity are simply intended to ensure that boilers operate efficiently regardless of the heating-load demand.</i></p>
<p>Best practices</p>	<p>System balancing: If utilizing a test and balance firm is not in the budget, a few simple steps during the startup and commissioning of a new or modified hydronic system can provide a rough system balance to help ensure the new system will perform up to design conditions and end-user expectations. The procedure for balancing using manual calibrated balance valves can be boiled down to a simple five-step process:</p> <ol style="list-style-type: none"> 1. Open all balance valves 100%, verify all air has been evacuated from the system and heat exchangers are properly plumbed. 2. This will help establish the pre-balance pump operating point and system flow rate. 3. There are many good choices of valves on the market. Look for a robustly built valve equipped with upstream and downstream pressure ports. 4. Moving away from the pumps, increase the percentage of full flow equally for each coil from the first to the end of piping and then return to the first coil to check the flow. 5. The system pressure should have risen, and the flows should be reduced from the starting point.³¹
<p>Frequently asked questions</p>	<p>Q: What are the requirements for variable volume and temperature (VVT) control installation? A: Section C403.4.2.1 states that "each zone shall be controlled by individual thermostatic controls capable of responding to temperature within the zone," which would cover the installation of a VVT system.</p>

³¹ [https://www.coolingbestpractices.com/system-assessments/chillers/industrial-hydronic-system-manual-balancing-methods](https://www.coolingbestpractices.com/system-assessments chillers/industrial-hydronic-system-manual-balancing-methods)

Common pitfalls	<p>An unbalanced system will result in:</p> <ul style="list-style-type: none">• Too hot in some areas of the building• Too cold in other areas of the building• Start-up after a set-back is difficult in some rooms• Installed power is not deliverable• Room temperatures fluctuate• Higher energy consumption than expected or desired <p>Hydronic balancing in industrial heating and cooling systems is often in startup and commissioning of new and modified hydronic systems. Insisting on a complete system balance upon startup of a new or modified system is an inexpensive insurance policy for any design engineer or installation contractor to protect their reputation against a system that is not performing to design conditions.</p>
-----------------	--

C403.4.3 Heat Rejection Equipment

<p><i>Each fan powered by a motor of 7.5 hp or larger shall have the capability to operate that fan at two-thirds of full speed or less and shall have controls that automatically change the fan speed to control the leaving fluid temperature or condensing temperature/pressure of the heat rejection device.</i></p> <p><i>Exception: Factory-installed heat rejection devices within HVAC equipment tested and rated in accordance with Tables C403.2.3(6) and C403.2.3(7).</i></p>	
New or modified information from ECCCNY-2014	Modified
Interpretation and Intent	<p><i>Heat rejection equipment covered by this section includes cooling systems, such as air-cooled condensers, cooling towers (open and closed circuit) and evaporative condensers. The exception excludes “factory-installed” devices because the fan energy is included in the efficiency ratings for that equipment.</i></p> <p>The most common heat rejecting equipment are condensers and cooling towers. Heat rejection is an integral part of the air-conditioning cycle, using air or water as the medium. Motors are typically designed to handle full load situations; therefore, it is vital to be able to have the capability to change the fan speed to control energy waste based on the regulation of heat rejection.</p>
Best practices	<p>Evaporative condensers offer important cost-saving benefits for most refrigeration and air-conditioning systems. They eliminate the problems of pumping and treating large quantities of water associated with water-cooled systems. They require substantially less fan horsepower than air-cooled condensers of comparable capacity and cost. Most importantly, systems utilizing evaporative condensers can be designed for a lower condensing temperature and subsequently lower compressor energy input, at a lower first cost, than systems utilizing conventional air-cooled or water-cooled condensers.</p> <p>Precise capacity control and energy savings are achieved with a variable frequency drive (VFD) option. VFDs offer a more efficient and durable way to reduce fan speed compared to fan cycling, fan discharge dampers, or mechanical speed changers. The inherent ability for VFDs to provide soft starts, stops, and smooth accelerations prolongs the mechanical system life of fans, motors, belts, bearings, etc. Sound levels are also reduced at lower fan speeds, and start-up noise is eliminated with the soft start feature.³²</p>
Common pitfalls	<p>Variable-Speed Drive (VSD): Adjustable frequency drives can be added to the motors for speed control. This method provides the best temperature control performance and is the most energy-efficient method of control. It may also be the most expensive initial cost, but studies indicate that the payback period in most cases is less than 18 months. When comparing VSDs with other approaches, the cost of control points for each alternative should be carefully factored into the analysis. VSD fans should not be run at the “critical” speeds. These are speeds that form resonance frequency vibrations and</p>

³² <http://www.baltimoreaircoil.com/english/products/evaporative-condensers/cxvb/engineering-considerations>

	can severely damage the fans. Gear drives, used in cooling towers, will limit minimum fan speed to 50% to provide adequate gear lubrication unless an oil pump is installed. Otherwise, minimum fan speeds of 10% are required to provide necessary motor cooling. ³³
--	--

³³ <https://www.cedengineering.com/userfiles/Heat%20Rejection%20Options.pdf>

C403.4.4 Requirements for Complex Mechanical Systems Serving Multiple Zones

C403.4.4 Requirements for complex mechanical systems serving multiple zones. Sections C403.4.4.1 through C403.4.6.4 shall apply to complex mechanical systems serving multiple zones. Supply air systems serving multiple zones shall be variable air volume (VAV) systems that, during periods of occupancy, are designed and capable of being controlled to reduce primary air supply to each zone to one of the following before reheating, recooling, or mixing takes place:

1. *Thirty percent of the maximum supply air to each zone.*
2. *Three hundred cfm or less where the maximum flow rate is less than 10% of the total fan system supply airflow rate.*
3. *The minimum ventilation requirements of Chapter 4 of the International Mechanical Code.*
4. *Any higher rate that can be demonstrated to reduce overall system annual energy use by offsetting reheat/recool energy losses through a reduction in outdoor air intake for the system, as approved by the code official.*
5. *The airflow rate required to comply with applicable codes or accreditation standards, such as pressure relationships or minimum air change rates.*

Exception: The following individual zones or entire air distribution systems are exempt from the requirement for VAV control:

1. *Zones or supply air systems where not less than 75% of the energy for reheating or providing warm air in mixing systems is provided from a site-recovered or site-solar energy source.*
2. *Zones where special humidity levels are required to satisfy process needs.*
3. *Zones with a peak supply air quantity of 300 cfm or less and where the flow rate is less than 10% of the total fan system supply airflow rate.*
4. *Zones where the volume of air to be reheated, re-cooled or mixed is not greater than the volume of outside air required to provide the minimum ventilation requirements of Chapter 4 of the International Mechanical Code.*
5. *Zones or supply air systems with thermostatic and humidistatic controls capable of operating the supply of heating and cooling energy to the zones in sequence and can prevent reheating, recooling, mixing, or simultaneous supply of air that has been previously cooled or heated, mechanically or through the use of economizer systems.*

New or modified information from ECCCNY-2014	Modified
Interpretation and Intent	The intent of this provision is to regulate fan energy use in multi-zoned mechanical systems using VAV systems, such that energy is not wasted. VAV systems modulate airflow not temperature.
Best practices	Use integrated design. Integrated design is defined as follows: <ol style="list-style-type: none"> 1. The architect, structural engineer, and mechanical designer should engage early to coordinate shafts for low-pressure air paths. 2. All parties should work together to evaluate glazing and shading alternatives to mitigate load, glare, and radiant discomfort while providing daylight, views, and architectural pizzazz.

	3. Prior to starting the mechanical design for any space, first consider the potential to reduce or minimize the loads on each space.
Frequently asked questions	<p>Q: A project team plans to reuse the main chillers, but they are redoing the ductwork, adding new ducts, and Variable Air Volume (VAV) terminals with heating coils. What are the relevant requirements?</p> <p>A: The new ductwork and VAV terminals must comply with the Energy Code. Keep in mind that while COMcheck™ is a helpful tool to show compliance, it is not likely to cover the requirements for new ductwork or VAV systems very well. For the VAV system, refer to the requirements outlined in Section C403.4.4 and make sure the information submitted is adequate. Additionally, verify information provided regarding controls for the HVAC system as this is not entirely captured by COMcheck™. In summary, do not rely on COMcheck™ entries alone; check submittals against the actual code requirements.</p>
Common pitfalls	Traditional design can be a fragmented process where each consultant (architect, mechanical engineer, electrical engineer) works exclusively on the aspects of the design that fall under their scope of services. Integrated design is a process that has a more collaborative multidisciplinary approach to better integrate the building design, systems, and controls. Issues not traditionally the purview of the mechanical designer have great impact on the cost, efficiency, and success of their design. For example, the glazing selected by the architect impacts the thermal loads and might prevent occupants in perimeter spaces from being comfortable due to visual glare or excessive radiant asymmetry. Use of high-performance glazing or shading devices can drastically reduce the size of the mechanical equipment and improve occupant comfort and create a solution to a common glazing problem. ³⁴

³⁴ http://www.taylor-engineering.com/Websites/taylor-engineering/images/guides/EDR_VAV_Guide.pdf

C403.4.5 Heat Recovery for Service Water Heating

<p><i>Condenser heat recovery shall be installed for heating or reheating of service hot water provided that the facility operates 24 hours a day, the total installed heat capacity of water-cooled systems exceeds 6,000,000 Btu/hr of heat rejection, and the design service water heating load exceeds 1,000,000 Btu/h. The required heat recovery system shall have the capacity to provide the smaller of the following:</i></p> <ol style="list-style-type: none"> <i>1. Sixty percent of the peak heat rejection load at design conditions.</i> <i>2. The preheating required to raise the peak service hot water draw to 85°F.</i> <p><i>Exceptions:</i></p> <ol style="list-style-type: none"> <i>1. Facilities that employ condenser heat recovery for space heating or reheat purposes with a heat recovery design exceeding 30% of the peak water-cooled condenser load at design conditions.</i> <i>2. Facilities that provide 60% of their service water heating from site solar or site recovered energy or from other sources.</i> 	
New or modified information from ECCCNY-2014	Unchanged
Interpretation and Intent	Section C403.4.5 requires condenser heat recovery for service water heating in systems that operate for 24 hours and are above certain thresholds for heating capacity and heating loads. When a building has a simultaneous need for chilled and hot water, chilling packages with heat recovery capabilities are available. Instead of leaving the system entirely via the condenser, this byproduct heat is recovered and used to provide hot water for various applications. Systems like this are commonly found in commercial building types such as hotels, hospitals, and certain higher education facilities.
Best practices	Heat is typically reclaimed for service water heating systems with two tanks; one for reclaim and one that includes the primary heat source. This system allows the heat reclaim tank temperature to rise until it reaches the service water heating temperature set point. A tank configuration allows heat to be transferred from the refrigeration system to the tank constantly, even without domestic hot water demand.
Common pitfalls	As the temperature of the tank rises, the heat that can be transferred from the refrigerant is reduced. In some instances, a heat exchanger between the entering cold water and the refrigerant might be a better alternative. The temperature difference is always maximized in this configuration. The system's drawbacks are the high, initial cost and its inability to transfer heat without hot water demand. ³⁵

³⁵ <https://www.nrel.gov/docs/fy15osti/63786.pdf>

C403.4.6 Hot Gas Bypass Limitation

<p><i>Cooling systems shall not use hot gas bypass or other evaporator pressure control systems unless the system is designed with multiple steps of unloading or continuous capacity modulation. The capacity of the hot gas bypass shall be limited as indicated in Table C403.4.6, as limited by Section C403.3.1.</i></p>	
<p>New or modified information from ECCCNYS-2014</p>	<p>Modified</p>
<p>Interpretation and Intent</p>	<p><i>Hot gas bypass is a control strategy used in commercial cooling and refrigeration equipment that allows cooling compressors to remain online at low load in colder weather by raising the condenser pressure. Many new commercial units have hot gas bypass systems, and have the capacity to modulate or unload capacity, which saves energy.</i></p>
<p>Best practices</p>	<p>Another method is to bypass the hot discharge gas to the evaporator inlet, usually between the thermal valve and the refrigerant distributor. This provides distinct advantages. The artificial load imposed on the evaporator causes the thermal valve to respond to the rise in superheat, eliminating the need for the liquid injection valve. The evaporator serves as an excellent chamber to provide homogeneous mixing of the gases before reaching the compressor.</p>
<p>Common pitfalls</p>	<p>Hot gas bypass into the evaporator is suggested when the evaporator elevation is below the compressor to prevent oil trapping caused by low velocity at low loads. This assures proper oil return. Although there are many advantages to this system, it is not used on a multiple coil system, or where the evaporator sections may be located a distance from the compressor. The coil should be a free draining circuiting design to prevent the increase in velocity, due to forcing a large quantity of trapped liquid out of the low side, which in some cases may have enough volume to flood the compressor crankcase. Separate regulators must be used for each evaporator when bypassing to multiple evaporators located below the compressor to help oil return. Bypass to flooded evaporators and suction line accumulators also present special cases. Contact the equipment manufacturer or the bypass control valve manufacturer for specific, detailed information.³⁶</p>

³⁶ <http://www.emersonclimate.com/Documents/FlowControls/pdf/2004FC-141-R7.pdf>

C403.5 Refrigeration Systems

<p><i>Refrigerated display cases, walk-in coolers or walk-in freezers served by remote compressors and remote condensers not located in a condensing unit, shall comply with Sections C403.5.1 and C403.5.2.</i></p> <p><i>Exception: Systems where the working fluid in the refrigeration cycle goes through both subcritical and supercritical states (transcritical) or that use ammonia refrigerant are exempt.</i></p>	
New or modified information from ECCCNY-2014	Modified
Interpretation and Intent	This section describes requirements for condensers serving refrigeration systems (Section C403.5.1) and compressor systems (Section C403.5.2).
Best practices	<p>Adding VFDs to condenser fans has several advantages and will give better condensing pressure control, which can smooth system operation. VFDs are used to lower off-peak fan power usage. Condensers need to be sized for peak loads, meaning for all loads except for a few peak conditions when they are oversized. Reducing the fan speed to match the capacity will give considerable horsepower savings. As fan speed drops, power consumption drops by the cube of fan speed (50% fan speed = 12.5% fan power). (See Best Practice for C403.4.3 Heat Rejection)</p> <p>Commissioning and well-considered operation and maintenance practices contribute to the long-term energy performance of the system. Encourage facilities to implement a robust energy management program. A successful energy management program allows a facility to sustain and improve the efficiency benefits that have been achieved. Key elements of a successful energy management program include tracking Key Performance Indicators (KPIs) of system efficiency, ensuring that key personnel receive appropriate training, and creating a culture that embraces a continuous improvement philosophy towards energy efficiency.</p>
Common pitfalls	Not considering life-cycle costs when installing or upgrading industrial refrigeration systems is common. The equipment-supply and design-build businesses are very cost-competitive, and facility owners have limited capital budgets. Therefore, system design often emphasizes low initial cost rather than low life-cycle cost. Energy costs are the most significant.

C404.8 Drain Water Heat Recovery Units

Drain water heat recovery units shall comply with CSA B55.2. Potable water-side pressure loss shall be less than 10 psi (69 kPa) at maximum design flow. For Group R occupancies, the efficiency of drain water heat recovery unit efficiency shall be in accordance with CSA B55.1.

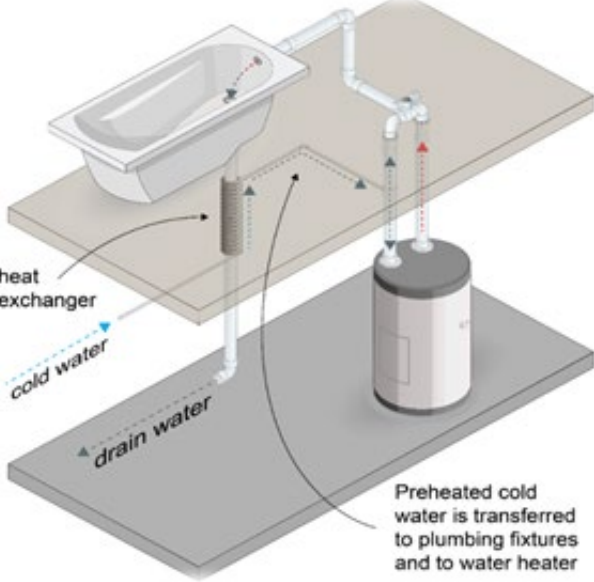
New or modified information from ECCCNY-2014	New
Interpretation and Intent	<p>Figure 21. DWHR unit showing placement of heat exchanger</p>  <p>The reuse of warm drain water is an often-ignored means of energy conservation in commercial buildings. Drain water heat recovery (DWHR) is not a mandatory code requirement, but they are especially useful in commercial building types such as hotels, laundry facilities, and restaurants. Cold water going through the heat exchanger (shown in Figure 21) should not have a pressure loss exceeding 10 psi.</p>
Best practices	<p><i>Drain water heat recovery (DWHR) works particularly well where heated water flows down the drain at the same time supply water needs to be heated, as with a demand (tankless) water heater.</i></p>
Common pitfalls	<p>Retrofitting existing commercial buildings with DWHR units can pose a challenge. Not all existing buildings have drain system configurations with an adequate length of a accessible vertical drain line, while others have long distances between their drain pipes and water heating systems.³⁷</p>

³⁷ <http://www.seventhwave.org/publications/drain-water-heat-recovery-field-study-commercial-applications>

C404.9 Energy Consumption of Pools and Permanent Spas (Mandatory)

The energy consumption of pools and permanent spas shall be controlled by the requirements in Sections C404.9.1 through C404.9.3.

C404.9.1 Heaters. The electric power to all heaters shall be controlled by a readily accessible on-off switch that is an integral part of the heater, mounted on the exterior of the heater, or external to and within three feet of the heater. Operation of such switch shall not change the setting of the heater thermostat. Such switches shall be in addition to a circuit breaker for the power to the heater. Gas-fired heaters shall not be equipped with continuously burning ignition pilots.

C404.9.2 Time switches. Time switches or other control methods that can automatically turn off and on heaters and pump motors according to a preset schedule shall be installed for heaters and pump motors. Heaters and pump motors that have built-in time switches shall be in compliance with this section.

Exceptions:

- 1. Where public health standards require 24-hour pump operation.*
- 2. Pumps that operate solar- and waste-heat-recovery pool heating systems.*

C404.9.3 Covers. Outdoor heated pools and outdoor permanent spas shall be provided with a vapor-retardant cover or other approved vapor-retardant means.

Exception: Where more than 70% of the energy for heating, computed over an operating season, is from site-recovered energy such as from a heat pump or solar energy source, covers, or other vapor-retardant means shall not be required.

New or modified information from ECCCNY-2014

Modified

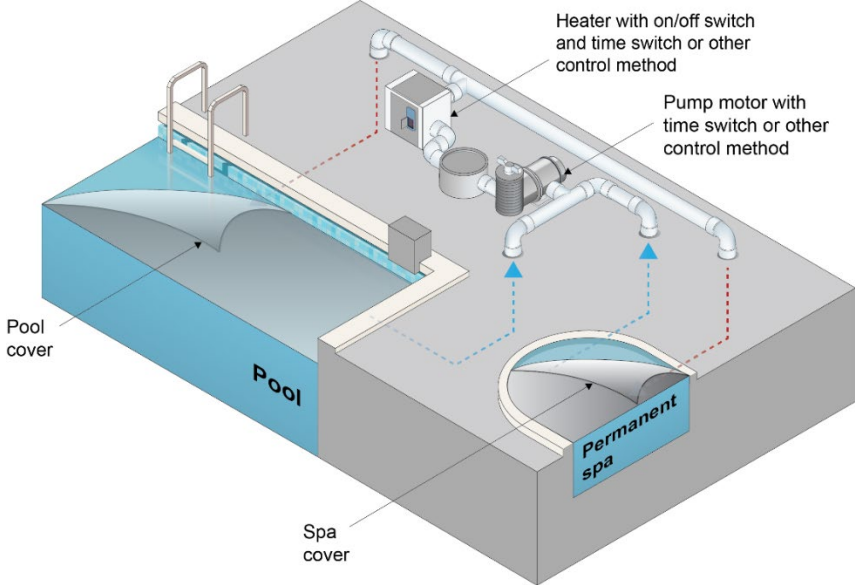
<p>Interpretation and Intent</p>	<p>Swimming pool and spa operations can use significant amount of energy to heat and filter water. This heat energy is lost when the air temperature at the water surface is lower than the pool or spa water temperature and through evaporation. To conserve energy, Section C404.9 sets requirements for pool and spa heaters, time switches, and covers. Code-compliant, vapor-retardant pool covers can greatly limit water lost to evaporation.</p> <p><i>Though not defined in the Energy Code, “pool” in this context refers to “swimming pool,” which is defined in the 2015 IBC as “any structure intended for swimming, recreational bathing or wading that contains water over 24 inches deep. This includes in-ground, above-ground and on-ground pools, hot tubs, spas, and fixed-in-place wading pools.”</i></p> <p>Figure 22. Pools and permanent spas</p> 
<p>Best practices</p>	<p>Automatic and semi-automatic pool covers can further lower annual heating costs and reduce the need for make-up water. Evaporation can account for up to 70% of energy losses in both indoor and outdoor swimming pools.³⁸</p>
<p>Common pitfalls</p>	<p>Carefully consider de-humidification needs for indoor pools during the design phase to prevent costly water damage and possible repairs.³⁹</p>

³⁸ <https://energy.gov/energysaver/swimming-pool-covers>; <https://aquamagazine.com/retail/the-case-for-automatic-pool-covers.html>

³⁹ <https://www.dxair.com/pool-room-design-guidelines/common-mistakes-when-building-an-indoor-swimming-pool/>

C404.10 Energy Consumption of Portable Spas (Mandatory)

<i>The energy consumption of electric-powered portable spas shall be controlled by the requirements of APSP 14.</i>	
New or modified information from ECCCNY-2014	New
Interpretation and Intent	The Association of Pool and Spa Professionals (APSP) offers a range of services that include setting and advocating industry standards that serve the interests of the consumer and the industry. ASPA 14 addresses water-heating equipment, pump motors, and covers
Best practices	Most portable spas use electric resistance heating. In addition to this heat source, waste heat from the spa's pump can be used to supplement and further increase the overall system efficiency.
Common pitfalls	Similar to pools and permanent spas, portable spas lose most of their heat energy to evaporation. To reduce these energy losses, portable spas should use well-insulated, tight-fitting covers with a hinge design that leaves few gaps. ⁴⁰

⁴⁰ http://www.energy.ca.gov/appliances/2013rulemaking/documents/12-AAER-2G/comments/Portable_Electric_Spas_Final_CASE_Report_12-AAER-2G_2014-05-15_TN-73027.pdf

C405.3 Exit signs (Mandatory)

<i>Internally illuminated exit signs shall not be more than 5 watts per side.</i>	
New or modified information from ECCCNY-2014	Unchanged
Interpretation and Intent	<p>There are two approved types of exit signs: internally illuminated and externally illuminated.</p> <p>Interior exit signs can use a maximum of 5 watts per face. This essentially requires use of LED exit signs.⁴¹</p>
Best practices	<p>In addition to fulfilling specific code requirements, using LED exit signs also lowers overall building energy usage. LED is one of today's most energy-efficient and rapidly-developing lighting technologies. Quality LED light bulbs last longer, are more durable, and offer comparable or better light quality than other types of lighting. Many utilities in New York State offer rebates for LED lighting projects.</p> <p>Use of Photoluminescent (PL) exit signs, which are non-electrical, will eliminate operating costs. PL exit signs are budget friendly and don't need electricity or batteries to operate, saving energy, money, and maintenance time. They provide exceptional reliability and efficient to operate. PL exit signs comply with NYC building and fire safety codes.</p>
Common pitfalls	<p>Exit signs are a critical health, life, and safety product. In the case of photoluminescent exit signs, ensure that they are specified with the ability to remain visible for a minimum of eight hours after being exposed to light, which is a requirement of NYC code.</p> <p>Emergency lights and exit signs often do not get much attention until they are needed. To ensure a safe evacuation in an emergency:</p> <ul style="list-style-type: none"> • Make sure that all exit paths are adequately lit • Post appropriate signage • Ensure the building commissioning plan contains proper maintenance procedures for emergency lights and exit signs, including • Monthly and annual inspections and up-to-date record keeping

⁴¹ Urban Green Council Conquer the Code presentation

C504 Repairs

<p><i>C504.1 General. Buildings and structures, and parts thereof, shall be repaired in compliance with Section C501.3 and this section. Work on non-damaged components that is necessary for the required repair of damaged components shall be considered part of the repair and shall not be subject to the requirements for alterations in this chapter. Routine maintenance required by Section C501.3, ordinary repairs exempt from permit and abatement of wear due to normal service conditions shall not be subject to the requirements for repairs in this section.</i></p>	
<p>New or modified information from ECCCNY-2014</p>	<p>New</p>
<p>Interpretation and Intent</p>	<p>Commercial building repairs fall under Chapter 5 [CE] Existing Buildings. This Chapter provides the requirements for the unique circumstances involved in existing building additions, alterations, and repairs. It's essential to define and distinguish the difference between a repair, alteration, and addition because repairs are not subject to the Energy Code, but alterations and additions are.</p> <ul style="list-style-type: none"> • Addition: An extension or increase in the conditioned space floor area or height of a building or structure. • Alteration: Any construction, retrofit, or renovation to an existing structure other than repair or addition that requires a permit. Also, a change in a building, electrical, gas, mechanical, or plumbing system that involves an extension, addition, or change to the arrangement, type, or purpose of the original installation that requires a permit. • Repair: The reconstruction or renewal of any part of an existing building for its maintenance or to correct damage.
<p>Best practices</p>	<p>When any building component is repaired, energy efficiency should be considered. Replacing only a bulb or ballast or both within an existing luminaire, is not subject to the energy code provided the replacement does not increase the installed interior lighting power. However, given new technology, such as LED or CFL light bulbs or electronic ballasts, it is a best practice to replace with high-efficiency components.</p>
<p>Frequently asked questions</p>	<p>Q: A roof's membrane has been damaged during a storm and the underlying insulation does not meet the current Energy Code. Is new or additional insulation required? A: This situation would fall under the repair category, as the new roof membrane is being installed to correct unintended damage. If a project team had <i>intentionally</i> removed the membrane, then this would be a reroofing project and it would have to meet current Energy Code requirements.</p>
<p>Common pitfalls</p>	<p>Repairs should never increase the preexisting energy consumption of the repaired component, system, or equipment.</p>

C505 Change of Occupancy or Use

<p><i>Spaces undergoing a change in occupancy that would result in an increase in demand for either fossil fuel or electrical energy shall comply with this code. Where the use in a space changes from one use in Table C405.4.2(1) or C405.4.2(2) to another use in Table C405.4.2(1) or C405.4.2(2), the installed lighting wattage shall comply with Section C405.4.</i></p>	
New or modified information from ECCCNY-2014	New
Interpretation and Intent	<p>In all buildings, each space is classified by use, or occupancy category found in the building code. Buildings are then provided with energy efficiency, structural, and life-safety elements for that use. When the occupancy of a space changes, the building design must be re-evaluated for that use. Examples of a change of occupancy would be changing an office to a retail store or a restaurant or changing a retail store to a residential building.</p> <ol style="list-style-type: none"> 1. If a change in occupancy is determined, then the building needs to comply with energy code provisions 2. If it increases demand for fossil fuel or electricity energy 3. If increase in demand is satisfied by renewables, does not need to comply 4. Lighting must comply according to new use
Best practices	<p>Operational and occupancy changes in commercial buildings can cause issues within certain building systems, such as mechanical, electrical, and controls systems. This hinders optimal building performance.</p> <p>Commissioning in existing buildings, known as retro-commissioning, helps ensure a building's systems are meeting the new, unique needs of its owner and occupants, operating efficiently, and providing a safe, comfortable work environment. At the time of an occupancy change, retro-commissioning should occur to help to ensure that building equipment and systems are performing together effectively and efficiently.⁴²</p>
Frequently asked questions	<p>Q: What requirements apply to unconditioned storage space being converted into conditioned office space? A: This is a change of use that would increase energy consumption, so it would have to meet new construction requirements.</p> <p>Q: Is system commissioning required for an existing building changing use? A: If the change in use is determined to use more energy than before, the building must comply with Energy Code commissioning requirements as if it were new construction. Lighting controls must be commissioned without exception.</p>
Common pitfalls	<p><i>Note that a change in occupancy or use is not necessarily a change in occupancy classification. For instance, if a grocery store is changed to a drugstore, this constitutes a change in occupancy, but not a change in occupancy classification, because both are mercantile occupancies.</i></p>

⁴² <http://www.buildingefficiencyinitiative.org/articles/retro-commissioning-significant-savings-minimal-cost>

4.5 Additional Commercial Code Provisions

For additional information on these commercial Energy Code provisions, please see UGC's Conquer the Code (updated December 2016):

- C401 General
- C402 Building Thermal Envelope
- C403 Building Mechanical Systems
- C404 Service Water Heating
- C405 Electrical Power and Lighting Systems
- C406 Additional Efficiency Package Options
- C407 Total Building Performance
- C408 System Commissioning
- C501 Existing Buildings
- C502 Additions
- C503 Alterations
- C504 Repairs
- C505 Change of occupancy or use

Please see the Frequently Asked Questions section for questions pertaining to the provisions in the list. For ease in navigation, the FAQs are listed in the same order as the provisions appear in the Energy Code.

4.6 Frequently asked questions

4.6.1 C401 General

C404.1 Scope

Q: A single project contains two buildings atop one another: a one-story Type I building with below-grade parking, and an apartment building. Can one building comply with ASHRAE 90.1-2013 and 2016 Supplement while the other building complies with the 2015 IECC and 2016 Supplement?

A: Yes, but this project would need to be submitted as two separate projects.

Q: What are the requirements for a conditioned space within a larger unconditioned space?

A: Unless the design heating requirement for the smaller space is less than 3.4 Btu/ft², this space must meet all commercial Energy Code requirements.

C401.2 Application

Q: What are the pros of each compliance path option (prescriptive, COMcheck, etc.)?

A: The prescriptive path is the most straightforward compliance path and the easiest to use. COMcheck is free software that only allows trade-offs *within* each category (e.g., envelope). The performance path gives design teams the most flexibility, allowing trade-offs across all components, systems, and assemblies through the use of energy modeling software.

Q: When was COMcheck last updated? Does it incorporate the new Energy Code?

A: As of October 3, 2016, the most up-to-date version of COMcheck (4.0.5) was compatible with the 2016 Energy Code. There is no NYS-specific version of COMcheck, as New York did not adopt extensive amendments to the 2015 IECC or ASHRAE 90.1-2013.

Q: A project's building envelope shows compliance using the 2015 IECC and 2016 Supplement, but the mechanical engineer has chosen to show compliance using ASHRAE. The project's envelope does *not* comply using ASHRAE. Overall, does this project comply with the Energy Code?

A: No. The Energy Code does not permit the selection of different compliance paths for regulated systems. A commercial building must comply entirely either with the 2015 IECC and 2016 Supplement or ASHRAE 90.1-2013 and the 2016 Supplement.

Q: What Energy Code provisions allow building envelope trade-offs?

A: Please refer to Section C401.2 and Section C407. These specifically allow for demonstrating compliance via a performance path, whereby the Energy Use or Annual Energy Cost of the proposed building is equal to or less than that of the standard reference building.

Q: How can a firm retrieve a previous version of COMcheck to verify an old project's compliance with an earlier version of the Energy Code?

A: DOE maintains COMcheck versions based on the current model code and the two previous versions of the model code. Queries about obtaining older versions of the COMcheck software itself should be directed to the BECP help desk: <https://www.energycodes.gov/HelpDesk>

4.6.2 C402 Building Envelope Requirements

C402.1 General (Prescriptive)

Q: How can the U-factor tables allow for more design options in exterior wall systems?

A: The U-factor component table allows for the calculation of the overall U-factor of that assembly (i.e., above-grade walls) that considers the entire assembly, from inside air film, to all contents of the wall system, to the outside air film. Many material U-factors are listed in Appendix A of ASHRAE 90.1-2013 to use for the overall component calculation.

Q: Table C402.1.3 does not include structural insulated panels (SIPs). What are those requirements?

A: Footnote A of Table C402.1.3 permits the use of ASHRAE 90.1-2013, Appendix A to determine the U-factor of a wall assembly to verify compliance, which works for a frame wall with no cavity insulation covered with SIPs. For a heavy timber frame covered with SIPs, use the manufacturer's values to determine compliance.

Q: A project team plans to use continuous insulation (CI) to allow for the fastening of exterior cladding. Does this rigid insulation still count towards the overall R-value of the wall assembly?

A: It depends. The Energy Code states that CI must be installed so that the only interruptions are service openings and fasteners for the insulation itself. Some cladding attachments interrupt the rigid insulation in a way that creates thermal bridging, reducing the effective R-value of the wall assembly.

Q: Can metal wall panels with integral insulation count towards CI requirements?

A: Any metal panels that create thermal breaks cannot be counted towards CI requirements. The metal would have to be at the outside face of the insulation only for the panel to count towards this requirement.

Q: Can CI be located on the inside face of a wall? Or do the interruptions at every floor slab/level cause this component to no longer function as continuous insulation?

A: This would be nearly impossible in a code-compliant multistory building, as the insulation (and the building envelope) would likely be broken at each floor level. For this reason, it is common practice to install continuous insulation outside of structural components.

Q: Can some wall assemblies be less efficient than code if other portions of the building are more efficient and, on average, the whole project meets or exceeds code? For example, Table C402.1.3 calls for CI under the prescriptive path. If *COMcheck* indicates a code-compliant building envelope without CI, is it still a requirement?

A: Yes, some prescriptive (but not mandatory) requirements may be traded off. If a project is using straightforward trade-offs, an area-weighted calculation could be done manually. For multiple trade-offs within the building envelope, *COMcheck* could be used. In the previously mentioned example, continuous insulation would not necessarily be required by utilizing the UA trade-off through *COMcheck*. For more extensive trade-offs, a project team would likely need to use the performance path and energy modeling software.

C402.2 Specific Building Thermal Envelope Insulation Requirements (Prescriptive).

Q: For roof insulation in a structural metal roof with purlins, a project team would like to install R-19 draped across the purlins with thermal blocks installed on top of the purlins and a layer of R-13 parallel to the purlins on top of the first layer. No liner system is being used. The project complies using *COMcheck* when using ASHRAE but not the IECC. Does this insulation configuration comply with the Energy Code?

A: Yes, but ASHRAE would then have to be used as the compliance path for the entire project. ASHRAE 90.1 includes insulation detail for a double layer of insulation installed with thermal blocks as described above. The IECC does not have these same provisions.

Q: In a four-story multi-use project, does the tenant separation wall between an apartment and a business need to be insulated as though it were an exterior wall?

A: No. The wall is not separating conditioned from unconditioned space. The requirements, primarily concerned with fire safety, require foams or sealants that have been tested to the required fire rating.

Q: Is an average R-value permitted with a 3" variation in insulation thickness?

A: The prescriptive path permits using an area weighted average U-factor if the insulation tapers 1" or less across the entire roof. Using the *COMcheck* method of compliance, tapers larger than 1" are allowed by calculating an average U-factor across the roof and using it to evaluate overall compliance.

Q: An existing building is being raised 2.5' to protect from high water. The project team plans to fill on the interior of the above-grade portion of the foundation wall and then pour a slab. They are proposing R-10 to extend 24" inward beneath the slab. Does this comply with the Energy Code? Does the above-grade portion of the wall need to be insulated?

A: If the block/foundation wall sits on a footer that is below the frostline, the block wall does not have to be insulated. However, the R-10 insulation should be brought up to the top of the slab to insulate the slab edge. The insulation can be cut back at a 45° angle. Even with such detailing, there will still be a thermal bridge along the exterior wall where the top-bond beam block meets the slab.

C402.4 Fenestration (Prescriptive)

Q: A project team designing a restaurant wants to use a full glass overhead door as part of their wall system on a busy pedestrian street. Can they use this overhead door as part of the building thermal

envelope even if it is open/up for the duration of normal business hours?

A: Full glass overhead doors can be part of the building thermal envelope, same as a standard size window. The U-factor, leakage rate, SHGC, and VT (if applicable) would all have to comply with the fenestration requirements of that climate zone.

Q: Can an all-glass, single-pane, heated conservatory meet code? Would it need to?

A: Conservatories and greenhouses are generally exempt from the building envelope requirements in Section C402. However, since this conservatory is heated, it would need to meet code, most likely using the performance path or ASHRAE.

Q: A hotel's proposed front façade has automatic sliding doors within a metal frame and a curtain wall with metal panels at the spandrels. The metal frame of the type of system is rarely thermally broken. How should the information for this façade be shown in COMcheck?

A: If available, use the manufacturer-provided values for the entire sliding door assembly. If this is not available, use software defaults. Spandrels are included in the definition of a curtain wall, and so are also counted as fenestration along with the other glazing area. However, the U-factor at the spandrels is most likely different than at the glazing, so these may need to be entered as two different window types.

Q: How should an all-glass project get around maximum fenestration ratio requirements?

A: This project could use energy modeling software and performance path to demonstrate compliance. Any deficits in building envelope efficiency would then be offset with higher efficiency mechanical equipment, better roof insulation, more efficient lighting, lower U-factor glazing, etc.

Q: Are skylights required in big box retail projects when using either the prescriptive path or COMcheck?

A: Yes. According to Section C402.4.2, either compliance paths would require skylights if the space meets the size and ceiling/roof heights.

Q: What information about SHGC should be submitted?

A: If selecting the prescriptive path, project teams should provide specs on the fenestration that show compliance with the requirements of Table C402.4.

Q: Can COMcheck be used to demonstrate SHGC compliance?

A: Projects can use COMcheck to input fenestration specifications for exterior wall assemblies. COMcheck requires this information to be input per the fenestration's specifications or for users to keep the default values. Generally, default values are not used.

C402.5 Air Leakage – Thermal Envelope (Mandatory)

Q: What is the reasoning behind increasingly stringent air leakage requirements?

A: Airtight buildings have many energy conservation benefits. Controlling infiltration and exfiltration creates more comfortable spaces for occupants. By controlling air leakage, project teams can also minimize heating and cooling loads, thereby downsizing the required systems and lowering annual operational costs.

Q: Can someone conduct a blower door test at 50 Pascals and then extrapolate this data to show what the infiltration rate would be at another pressure differential?

A: In this case, the blower door test result could be extrapolated to mirror one performed at another pressure differential by multiplying the initial test result by the appropriate coefficient.

Q: Are roof penetration sealing techniques such as pitch pockets and rubber pipe boots still allowed?

A: None of these techniques are prohibited, though it is typically preferable to have roofs only penetrated by shapes that can be easily flashed. The Energy Code allows penetrations through the building thermal envelope provided that all penetrations are sealed, gasketed, and caulked so that air barrier integrity is maintained.

Q: Are air barriers and vapor retarders required on all new buildings?

A: Air barriers are required by the Energy Code. They may be of any material that meets the air barrier material criteria and can be comprised of different materials if transitions are properly sealed to resist air movement. In the previous version of the Energy Code, requirements for vapor retarders were a subsection of air barrier requirements. Current vapor retarder requirements are explained in the 2015 IBC, Section 1405.3.

Q: A convenience store has a total footprint of 3,500 ft² with a 2,700 ft² merchandise area. The remaining 800 ft² contains a storage room, offices and restrooms. Is a vestibule required?

A: No. Section C402.5.7 includes an exemption for doors that open from a space of less than 3000 ft². Even though the total footprint of the building exceeds this, only the area(s) that directly communicate with the space within the entry count towards the 3000 ft² threshold. In this case, the separate rooms are not included as part of the open merchandise area.

4.6.3 C403 Building Mechanical Systems

C403.2 Provisions Applicable to All Mechanical Systems (Mandatory)

Q: What major changes in the Energy Code impact packaged rooftop units?

A: There are numerous changes. A few sections likely to be particularly relevant are as follows:

1. Changed minimum equipment efficiency requirements
2. Additional requirements for fan controls
3. Set point overlap restriction for some controls (Section C403.2.4.1.3)
4. Air leakage requirements for shutoff dampers (Section C403.2.4.3)
5. New economizer requirements, including fault detection and diagnostics (Section C403.2.4.7)
6. Ventilation and energy recovery, including demand control ventilation for each space > 500 SF with an average occupancy of 25 people/1000 SF (Section C403.2.6)

Q: What type of heating is allowed on a patio at a bar or restaurant?

A: Section C403.2.13, which contains requirements for heating outside of buildings, states that systems designed to provide heat outside of a building should be radiant heating systems.

Q: What are the mechanical submittal requirements for the new Energy Code?

A: Section C103.2 lists “mechanical system design criteria, mechanical and service water heating system and equipment types, sizes and efficiencies, economizer description, equipment and system controls, fan motor horsepower (hp) and controls, duct sealing, duct and pipe insulation and location.” More specific requirements for mechanical systems are in Section C403 and C404.

C403.2.2 Equipment sizing

Q: Can a mechanical system use one central return if adequate transfer openings are provided?

A: No Energy Code provision prohibits this. Transfer openings should be properly sized.

C403.2.3 HVAC equipment performance requirements

Q: Is it possible to input only HVAC equipment information into COMcheck?

A: Yes. COMcheck does not verify proper sizing of HVAC equipment, so there is no link between mechanical equipment and the building envelope.

Q: What is the minimum SEER level for air conditioners in New York State?

A: Please refer to Tables C403.2.3(1-10) for specific requirements.

Q: The 2016 Energy Code Supplement includes a statement amending ASHRAE 90.1-2013 efficiencies for VRF air conditioners. Does this mean that the Energy Code is adopting VRF efficiencies?

A: Technically, yes. The IECC does not include specific regulations for VRF, but for commercial project teams there is the option of complying with ASHRAE 90.1-2013.

Q: Does the Energy Code allow the installation of electric resistance heat in the renovation of existing multifamily units?

A: No Energy Code provision prohibits this.

C403.2.6 Ventilation

Q: If the natural ventilation rates are met in accordance with Section C402, is it still necessary to mechanically ventilate as outlined in Section C403.1?

A: No. Natural ventilation is not a substitute for mechanical ventilation requirements.

Q: Can an outside air intake damper be located several feet away from the exterior wall louver?

A: Yes, but that span of duct must be insulated to make the building thermal envelope continuous, as the duct walls are now separating conditioned space from unconditioned space.

C403.2.7 Energy Recovery Ventilation Systems

Q: When are energy recovery ventilation (ERV) systems required?

A: ERV systems become a code requirement when the supply airflow rate of a building's fan systems exceeds the thresholds specified in Tables C403.2.7(1) and C403.2.7(2). Section C403.2.7 also lists nine exceptions for ERV requirements.

C403.2.9 Duct and Plenum Insulation and Sealing

Q: A commercial project has no roof insulation and a suspended interior ceiling. Is uninsulated ductwork permitted, either above the ceiling or below it?

A: No. This project does not have a continuous thermal envelope, so its ductwork must be insulated. Ductwork in unconditioned space must be insulated to at least R-6.

Q: A section of ventilation ductwork runs through conditioned space, through the roof, and then extends a short distance above the roof. Does the ductwork need to be insulated?

A: Ductwork within conditioned space does not have to be insulated. However, both supply and exhaust ducts located outside the thermal envelope must be insulated to at least R-8 (Climate Zone 4) or R-12 (Climate Zones 5 and 6).

Q: Do exposed ducts within conditioned space require joint sealers?

A: Yes. Section C403.2.9 states that all ducts, air handlers, and filter boxes shall be sealed. Joints and seams shall comply with Section C603.9 of the IMC.

Q: Variable volume and temperature (VVT) systems can include the use of a "dump zone," which allows the system to relieve a percentage of the supply air directly into the plenum above the ceiling. Would this "dump zone" be considered excessive duct leakage from the system?

A: Duct leakage testing would not include testing of the "dump zone" box in an "open" condition, so a "dump zone" would not negatively impact any duct leakage testing results.

4.6.4 C404 Service Water Heating (Mandatory)

Q: What changes have been made to service water heating requirements?

A: The new Energy Code has expanded Section C404 to include two methods of compliance for determining heated water piping efficiency and service water commissioning.

4.6.5 C405 Electric Power and Lighting Systems

Q: Are daylighting controls required in all spaces?

A: Daylighting controls are required in spaces with greater than 150w of general lighting in the space. Section C405.2.3.1 describe the requirements for these controls.

4.6.6 C406 Additional Efficiency Package Options

Q: When is Section C406 required?

A: The Additional Energy Efficiency Option package section applies when the project team uses a prescriptive path, including the use of COMcheck software. Section C406 does not apply to project using Section C407. ASHRAE 90.1 does not have any additional efficiency package requirements.

Q: For the renewables option, what if all equipment is gas or oil fired rather than electric?

A: The second option accounts for whole building energy use regardless of source. If the renewables system can account for at least 3% of that use, then the system would be compliant with this option.

4.6.7 C408 System Commissioning

Q: Who can perform system commissioning?

A: The commissioning plan must be developed by a registered design professional or approved agency. This plan must include a list of the activities to be performed during each phase of commissioning and the personnel intended to accomplish each of the activities.

Q: When is system commissioning required?

A: Generally, commissioning kicks in on larger buildings. C408.2 has exceptions for mechanical systems and service water heating systems in buildings where the total mechanical equipment capacity is less than 480,000 Btu/h cooling capacity and 600,000 Btu/h combined service water heating and space heating capacity. Systems that serve individual dwelling units or sleeping units are exempt. Lighting system function testing is required per C408.3. If the budget allows, commissioning is a practice that should be included as often as possible even when not required by code.

Q: Is HVAC commissioning required when most of a system is being replaced?

A: In some cases, the new equipment will exceed the threshold for commissioning and will need to go through the commissioning process.

Q: If a single HVAC unit is replaced within a multi-unit system, does this require the whole building to be commissioned as the exceptions for commissioning do not apply here?

A: No, commissioning is not required. C501.1.1 states that the unaltered portion of the existing building or building supply system shall not be required to comply with this code.

4.6.8 C501 Existing Buildings

Q: A commercial building with landmark status is getting an updated HVAC system. Does this system need to comply with the current Energy Code?

A: With the entire HVAC system being replaced, this would be considered a "new" system according to

code and would therefore have to comply with Chapter 4 in the commercial code. Exceptions for historic buildings can be found in Section C501.6.

Q: What should be done when an existing building does not have a permit?

A: Once the year of construction is determined, the code(s) in effect at that time should be used.

4.6.9 C502 Additions

Q: How COMcheck be used to demonstrate Energy Code compliance for an addition?

A: Section C502.2 contains special provisions for calculating vertical fenestration, skylights, and design of building mechanical systems, service water systems, pools, lighting power, and systems as they relate to either standalone or an extension of the building systems.

Q: Can a project team calculate the skylight area of a solarium addition as a percentage of the existing building plus the solarium?

A: Additions may show compliance in isolation or together with the existing building.

4.6.10 C503 Alterations

Q: An existing building is being upgraded with new fenestration, doors, and lighting. Does the entire building then have to be brought up to compliance with the current Energy Code?

A: Unless the building is going through a change of use (see Section C505), then only the building components being changed must be brought up to code.

Q: Is there a compliance path in the Energy Code to permit a roof insulation taper of greater than 1" for reroofing projects with fixed roof drain elevations?

A: COMcheck treats alterations differently from new construction and does not permit a roof taper of greater than 1" on reroofing projects.

Q: How should a renovation project team verify that the heating system is the correct size?

A: An HVAC contractor or engineer should show the heat loss using ANSI/ASHRAE/ACCA Standard 183 or an approved equivalent computational procedure.

Q: If a membrane is removed from an existing roof system, how does this affect which Energy Code provisions apply to the renovation?

A: If an alteration does not increase an existing building's energy usage, Section C101.2.6 exempts reroofing "for roofs where neither the sheathing nor the insulation is exposed." However, roofs where sheathing or insulation is exposed during reroofing must be insulated.

5 Residential Energy Efficiency

5.1 Introduction

R101.2 Scope. The 2015 IECC Residential Provisions (as amended) apply to residential buildings, the sites on which residential buildings are located, and building systems and equipment in residential buildings.

Starting with the 2012 IECC, the scope of the Energy Code was expanded to include building sites and associated systems and equipment.⁴³

5.2 Definitions

Basement wall	A wall 50% or more below grade and enclosing conditioned space.
---------------	---

Building	Any structure used or intended for supporting or sheltering any use or occupancy or for affordingshelter to persons, animals or property, together with (a) any equipment, mechanical systems, service water heating systems, and electric power and lighting systems located in such structure, and (b) any mechanical systems, service water heating systems, and electric power and lighting systems located on the site where such structure is located and supporting such structure. The term “building” shall include, but shall not be limited to, factory manufactured homes (as defined in section 372(8) of the Executive Law) and mobile homes (as defined in section 372(13) of the Executive Law).
----------	--

Crawl space wall	The opaque portion of a wall that encloses a crawl space and is partially or totally below grade.
------------------	---

Demand recirculation water system	A water distribution system where pumps prime the service hot water piping with heated water upon demand for hot water.
-----------------------------------	---

Insulating sheathing	An insulating board with a core material having a minimum R-value of R-2.
----------------------	---

Residential building	The term “residential building” includes: <ol style="list-style-type: none">1. detached one-family dwellings having not more than three stories above grade plane2. detached two-family dwellings having not more than three stories above-grade plane3. buildings that (i) consist of three or more attached townhouse units and (ii) have not more than three stories above grade plane4. buildings that (i) are classified in accordance with Chapter 3 of the 2015 International Building Code (as amended) in Group R-2, R-3 or R-4 and (ii) have not more than three stories above grade plane5. factory manufactured homes (as defined in section 372(8) of the New York State Executive Law)6. mobile homes (as defined in section 372(13) of the New York State Executive Law)
----------------------	--

⁴³ “Energy Code Compliance Paths: Which One Will Work Best for Your Project?” Colorado Code Consulting, 2016. Retrieved from <https://www.energycodes.gov/sites/default/files/becu/EnergyCodeCompliancePaths.pdf>

7. For the purposes of this definition, the term “townhouse unit” means a single-family dwelling unit constructed in a group of three or more attached units in which each unit (i) extends from the foundation to roof and (ii) has open space on at least two sides

Sunroom	A one-story structure attached to a dwelling with a glazing area in excess of 40% of the gross area of the structure’s exterior walls and roof.
---------	---

Thermal isolation	Physical and space conditioning separation from conditioned space(s). The conditioned space(s) shall be controlled as separate zones for heating and cooling or conditioned by separate equipment.
-------------------	--

5.3 Major Residential Code Changes

1. New compliance path for residential buildings: The Energy Rating Index (ERI) (Section R406)
2. Mandatory residential air leakage testing (Section R402.4)
3. Enhanced residential high-efficacy lighting requirements (Section R404.1)

More information on these topics is included in Urban Green Council’s Conquer the Code (updated December 2016).

5.4 Detailed Residential Code Provisions

- R402.2.7 Walls with partial structural sheathing
- R402.2.13 Sunroom insulation
- R402.4.6 Tenant separation walls (Mandatory)
- R403.5.1.2 Heat trace systems
- R403.5.2 Demand recirculation systems
- R403.9 Snow melt and ice system controls (Mandatory)
- R403.10 Pools and permanent spa energy consumption (Mandatory)
- R403.11 Portable spas (Mandatory)
- R403.12 Residential pools and permanent residential spas
- R504 Repairs
- R505 Change of occupancy or use

R402.2.7 Walls with Partial Structural Sheathing

<p><i>Where Section R402.1.2 would require continuous insulation on exterior walls and structural sheathing covers 40% or less of the gross area of all exterior walls, the continuous insulation R-value shall be permitted to be reduced by an amount necessary to result in a consistent total sheathing thickness, but not more than R-3, on areas of the walls covered by structural sheathing. This reduction shall not apply to the U-factor alternative approach in Section R402.1.4 and the total UA alternative in Section R402.1.5.</i></p>	
<p>New or modified information from ECCCNY-2014</p>	<p>New</p>
<p>Interpretation and Intent</p>	<p>This exception in the code means that, in cases where structural sheathing covers 40% or less of the gross wall area, the following is permitted:</p> <ol style="list-style-type: none"> 1. The > 60% has the full required insulating sheathing R-value 2. The ≤ 40% has “sandwiched” structural and insulating sheathing with summed thickness equal to that of the full insulating sheathing and the R-value of this sandwiched sheathing is not reduced by any more than R-3 compared to the R-value of the full-thickness insulated sheathing.⁴⁴ <p>In cases where the second option is selected, the R-value of the continuous insulation may be reduced to achieve a consistent total sheathing thickness.</p> <p><i>This section accounts for the common situation when structural sheathing is used over a portion of the outside wall, such as at the corners for horizontal bracing. In those cases, the portion of the wall with structural sheathing may be thicker than the rest of the wall.</i></p>

⁴⁴ Residential Provisions of the 2015 International Energy Conservation Code. PowerPoint presentation. Building Energy Codes Program.

Figure 23. Wall with partial structural sheathing at corner

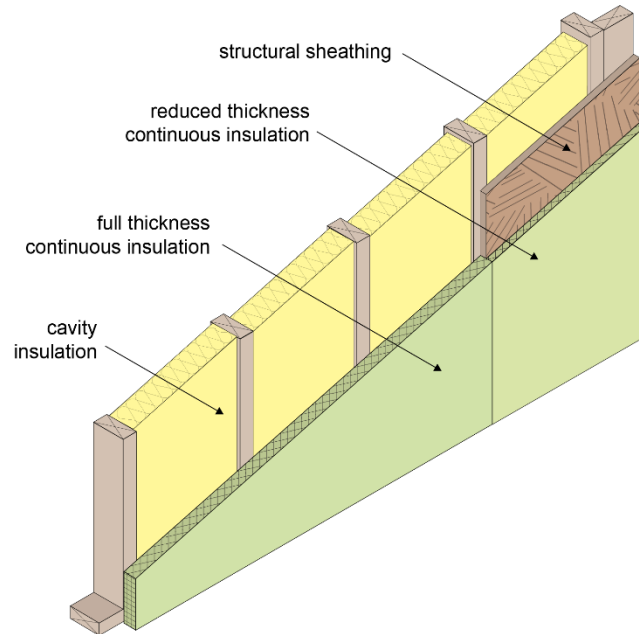

<p>Best practices</p>	<p>Rigid foam insulation and other non-structural sheathing products require additional support from structural sheathing products such as plywood and oriented strand board.</p>
<p>Common pitfalls</p>	<p>Code enforcement officials are looking for continuity of insulation and air barrier. Be sure to detail this provision on the plans for this common situation to facilitate plan review.</p>

R402.2.13 Sunroom Insulation

Sunrooms enclosing conditioned space shall meet the insulation requirements of the code.

Exception: for sunrooms with thermal isolation, and enclosing conditioned space, the following exceptions to the insulation requirements of this code shall apply:

1. *The minimum ceiling insulation R-values shall be R-19 in Climate Zones 4 and R-24 in Climate Zones 5 and 6.*
2. *The minimum wall R-value shall be R-13 in all climate zones. Walls separating a sunroom with a thermal isolation from conditioned space shall meet the building thermal envelope requirements of this code.*

New or modified information from ECCCNYS-2014	Unchanged
Interpretation and Intent	The intent of this provision is to allow flexibility and leniency in code requirements for sunrooms with thermal isolation.

Figure 24. Sunroom insulation requirements

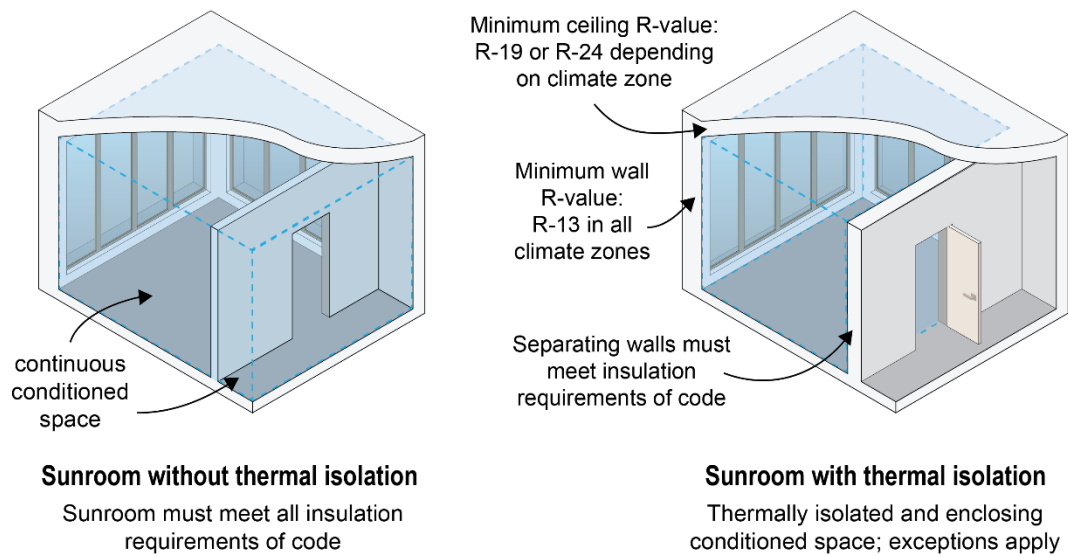

Best practices	<p>Sunrooms stand to benefit from green building and design philosophies more than other major home improvement. From a traditional building standpoint, windows are a major source of year-round energy loss, and can play a very detrimental role in reducing a home's overall energy efficiency. From a green design point-of-view, however, more south-facing windows means more natural light, comfortable and inviting homes, increased ventilation, and a valuable source of free passive solar heating, assuming the use energy-efficient materials and design. Following is a list of ideas to create the most energy-efficient sunroom possible:</p> <ol style="list-style-type: none"> 1. Install low-e, multiple paned windows with wood or vinyl frames primarily on the south side of the sunroom. This is probably the single most important step in designing a green sunroom. Without the benefit of traditional insulation to maintain consistent
----------------	--

	<p>indoor temperatures and prevent heat and cooling loss, low-e, multiple paned windows will function as the primary source of insulation.</p> <ol style="list-style-type: none"> 2. Install low solar gain windows in east- and west-facing walls. These windows utilize technology that reduces the heating effect of sunlight during summer months, and air conditioner runtime. 3. Install high-solar-gain windows in south-facing walls. South-facing windows are a prime source of passive solar heat (i.e., sunlight) during the winter. It is important to shade these windows in summer to reduce heat gain, which makes the room uncomfortable. 4. Build south facing sunrooms. Sunrooms with southern exposures will receive direct sunlight year-round, which is vital to make the most of passive solar heating during the winter. 5. Design with natural air movement in mind. Be sure to account for the direction and flow of natural air movement, and orient operable windows to facilitate air flow. Doing so will allow the most of natural cooling and ventilation during spring, summer, and fall. 6. Install ceiling fans and ventilation. Ceiling fans will help to circulate the air in a sunroom, leading to more consistent temperatures in every season. Installing a ventilation fan at the peak of the sunroom allows occupants to vent out hot air that accumulates there during warmer times of the year. 7. Install more insulation in the ceiling than required by code. Since most sunroom walls will be glass, it is important to put more insulation in the ceiling to keep the room more comfortable in both summer and winter. 8. Install radiant floor heating. Radiant floor heating is more efficient, provides a more even heat, and is perfect for use in a room like sunrooms where concrete, tile, or stone flooring is the norm.⁴⁵
Common pitfalls	<p>Adequate ventilation makes for a more comfortable and healthier sunroom. The suggested ventilation tips don't just make for an energy-efficient addition, they also mean a much more pleasant, healthier, and comfortable space.</p> <p>Good windows aren't just energy efficient. Properly insulated windows and adequate traditional insulation, where applicable, make for more stable indoor temperatures and more comfortable environments. They are also an excellent barrier against noise pollution, which can be a major nuisance in a room with as many windows as a sunroom.</p> <p>A common pitfall is not understanding the definition of a sunroom as stated in the code. Determine the gross area of the structure and show this calculation on the plans submitted to the local code enforcement official. If the room is a one-story structure attached to a dwelling with a glazing area in excess of 40% of the gross area of the structure's exterior walls and roof, and is thermally isolated, to take advantage of reduced insulation requirements.</p>

⁴⁵ <https://pro.homeadvisor.com/article.show.Going-Green-Sunrooms-and-Patio-Enclosures.16479.html>

R402.4.6 Tenant Separation Walls (Mandatory)

Fire separations between dwelling units in two-family dwellings and multiple single-family dwellings (townhouses) shall be insulated to no less than R-10 and the walls shall be air sealed in accordance with Section R402.4 of this chapter.

New or modified information from ECCCNY-2014	New
Interpretation and Intent	<p>The tenant separation wall shown in Figure 25 must perform two essential functions: fire safety and moisture resistance. Separation wall materials must be moisture resistant to prevent mold and deterioration, especially that which can occur during the construction process. Air sealing and insulation between dwelling units can also provide acoustic privacy.</p> <p style="text-align: center;"><i>Air sealing and insulation between dwelling units can save energy where space conditioning is individually controlled in each dwelling unit.</i></p> <p>More information on this topic is included in Urban Green Council's <i>Conquer the Code</i> (updated December 2016).</p>

Figure 25. Plan view of a tenant separation wall between adjacent dwelling units

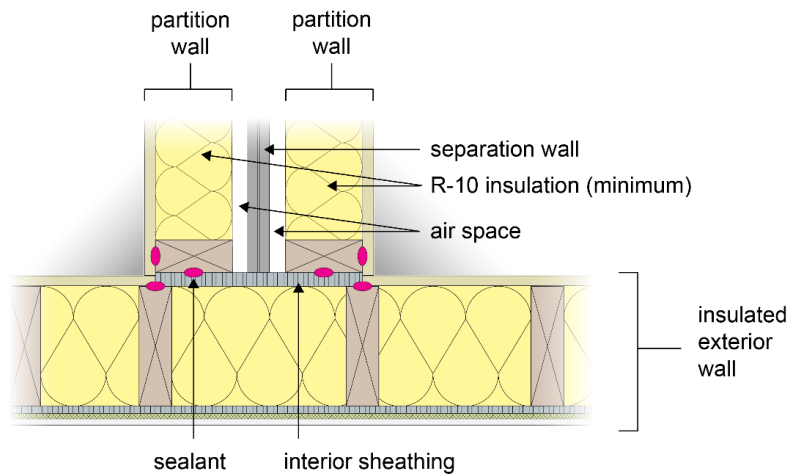

Best practices	<p>Buildings with two or more dwelling units are permitted to use Section R402.4.1.3 instead of Section R402.4.1.2 as a compliance option. This compartmentalized testing option measures air tightness of each dwelling unit, rather than the air loss from the entire multi-unit building. Buildings with more than seven units can use sample testing units as described in Section R402.4.1.3.1.</p> <p>If the required airtightness is compromised by leakiness in the separation wall, consider optimizing the building envelope elsewhere in addition to sealing the separation wall as much as possible. Any foams and sealants used should follow the required fire rating.</p>
Common pitfalls	<p>The residential building code requires that all tenant separation walls in townhomes are structurally independent. However, this can also lead to significant air leakage from outdoors and from adjacent units.</p>

R403.5.1.2 Heat Trace Systems

Electric heat trace systems shall comply with IEEE 515.1 or UL 515. Controls for such systems shall automatically adjust the energy input to the heat tracing to maintain the desired water temperature in the piping in accordance with the times when heated water is used in the occupancy.

New or modified information from ECCCNYS-2014

New

Interpretation and Intent

Figure 26. Example of heat trace system leading to residential bathroom

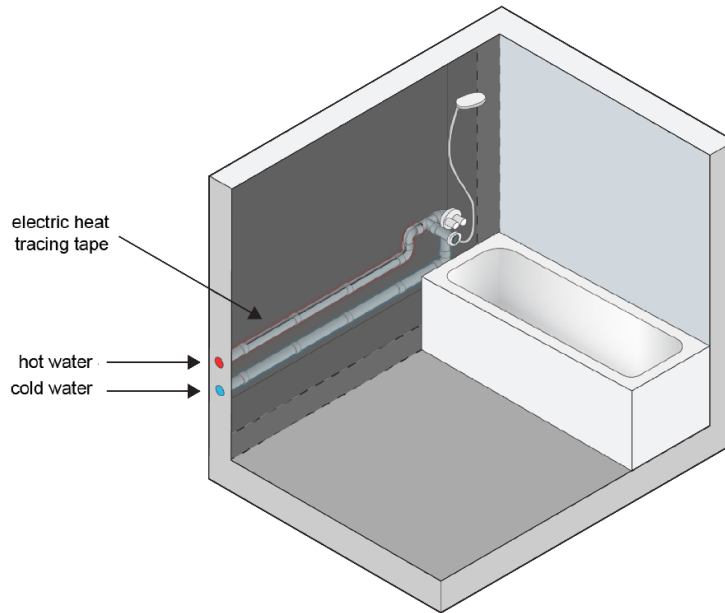

Heat trace systems are used for freeze protection or for providing heated water to the occupancy.

Figure 27. Detail of electric heat tracing cable with attachment tape

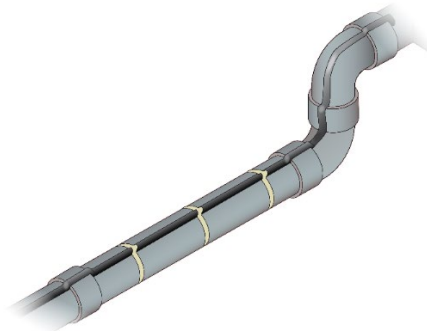

Best practices	<p>Water conservation has become a major concern in the past few years. The need to conserve water has led to requirements for the use of low-flow fixtures, including faucets, showers, and water closets. The water wastage that occurs when cooled water is dumped down the drain while the user is waiting for hot water to flow can no longer be tolerated. In addition to wasting a precious resource, this practice incurs extra energy costs to heat the water and extra waste treatment costs to process the wasted water. The ability to keep a pipe warm close to the point of use is of particular interest with the low-flow fixtures used today. A hot water, self-regulating, heat trace system can be used for prompt delivery of hot water at the fixtures. A heating cable system is one of several accepted methods of providing prompt delivery of hot water.</p>
Common pitfalls	<p>Knowing the function of the trace is critical when selecting the type of trace, heat trace monitoring methods, and the control scenarios for the trace. Heat trace does not come in a one size fits all package. When selecting a package:</p> <ol style="list-style-type: none"> 1. Compare the merits of heat tracing and a recirculation system based on the requirements of a specific project. 2. Identify the extent of piping requiring heat tracing. Self-Regulating Heat Trace Systems 3. Understand the role of thermal insulation in hot water heat tracing. 4. In coordination with an electrical engineer, determine the circuit breaker/power requirements based on the estimated heat tracing circuit lengths. 5. Translate the design requirements into a complete design for the project.

R403.5.2 Demand Recirculation Systems

A water distribution system having one or more recirculation pumps that pump water from a heated water supply pipe back to the heated water source through a cold-water supply pipe shall be a demand recirculation water system. Pumps shall have controls that comply with both of the following:

1. The control shall start the pump upon receiving a signal from the action of a user of a fixture or appliance, sending the presence of a user of a fixture or sensing the flow of hot or tempered water to a fixture fitting or appliance.
2. The control shall limit the temperature of the water entering the cold-water piping to 104°F (40°C)

New or modified information from ECCCNY-2014

New

Interpretation and Intent

This section explains the requirements for circulation pumps in demand recirculation systems that use a cold-water supply line. (Some other systems use dedicated ambient return lines.) When a demand recirculation system's temperature sensor is triggered, its pumps recirculate cooled water sitting in the hot water line back to the hot water heater via the cold-water line. When the hot water reaches the desired temperature, a control then switches off the recirculation pump.

Figure 28. Demand recirculation system cycle

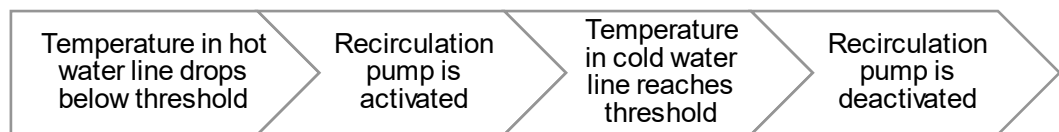
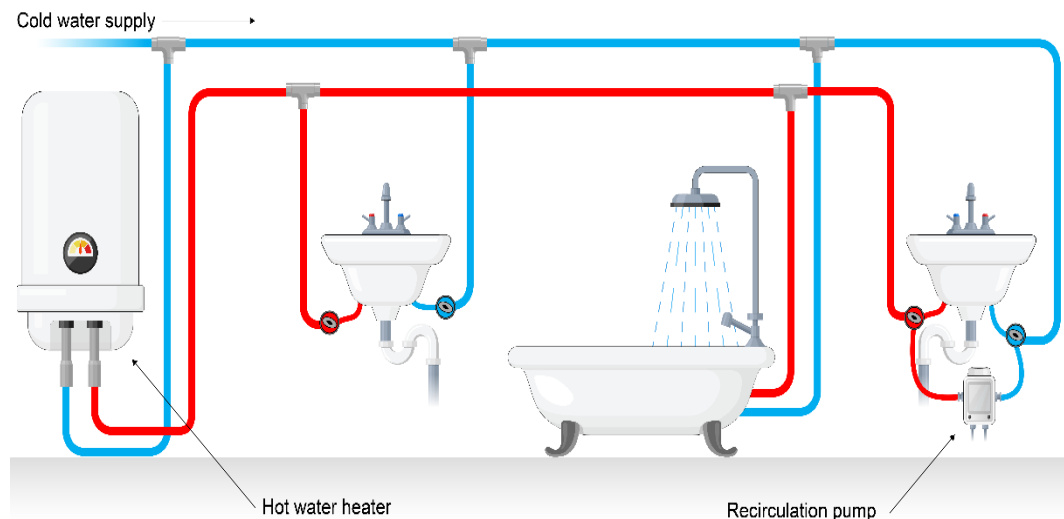

Figure 29. Typical system using a cold-water supply line



	The intent of this provision is to provide energy efficiency and safety to systems that use cold-water supply to circulate water back to a water heater.
Best practices	To save energy, homes should be designed with hot water distribution systems that minimize the time it takes the water heater to supply plumbing fixtures with hot water. Homes with long distances between hot water heaters and plumbing fixtures should consider utilizing a demand recirculation system, which is more energy efficient than continuous recirculation systems.
Common pitfalls	A balance exists between getting hot water quickly to all use points (and minimizing water waste) and the energy penalty associated with a larger recirculation loop. There is a point at which the loop length and water savings can be maximized, but it appears to be in systems with shorter recirculation loops and longer run-outs. Simply the reduction in distribution losses must balance out with the recirculation losses to maximize energy savings. Demand recirculation systems are not projected to provide energy savings relative to an already centrally located water heater with insulated lines for trunk and branch systems. Even by extending the run-outs and shortening the recirculation loop, there are marginal water-heater energy savings with demand recirculation. ⁴⁶

⁴⁶ <https://www.nrel.gov/docs/fy14osti/62848.pdf>

R403.9 Snow Melt and Ice System Controls (Mandatory)

Snow- and ice-melting systems, supplied through energy service to the building, shall include automatic controls capable of shutting off the system when the pavement temperature is above 50 °F (10 °C) and no precipitation is falling and an automatic or manual control that will allow shutoff when the outdoor temperature is above 40 °F (4.8C).

New or modified information from ECCCNY-2014	Unchanged
--	-----------

Interpretation and Intent

Figure 30. Snow and ice melt system sensor placement

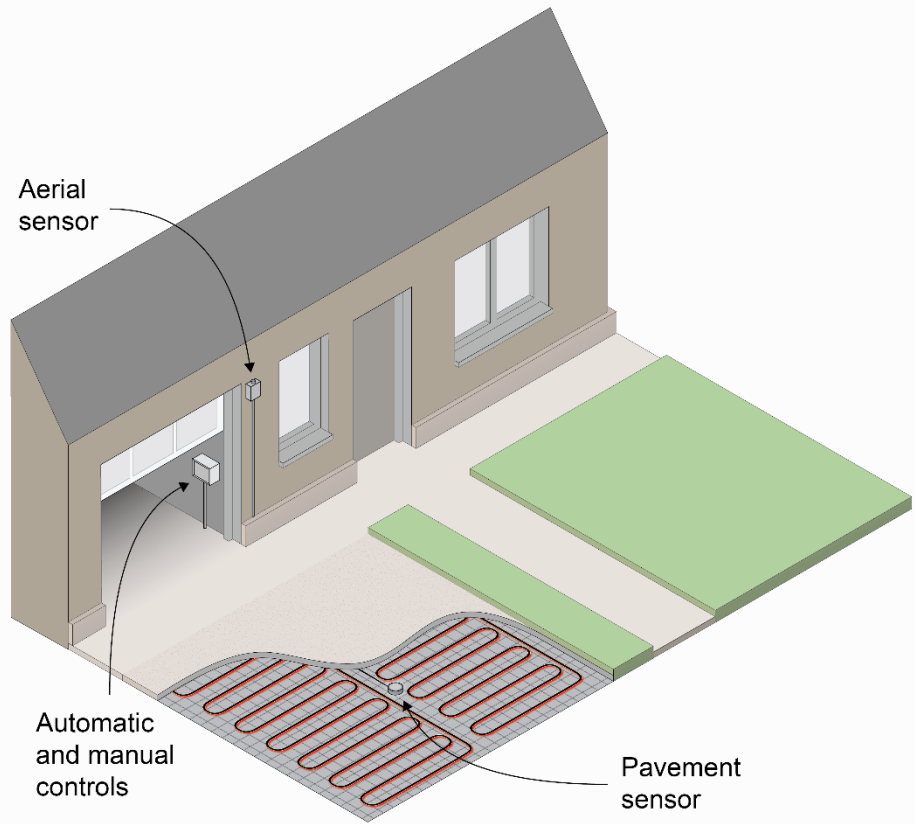

Snow and ice melt systems are used to remove snow and ice from walkways, driveways and roof eaves. These systems typically operate using embedded electric cables or hydronic piping. Automatic controls systems allow for energy-efficient operation, using aerial and pavement sensors (shown in Figure 30) to detect when precipitation is falling and when the temperature falls below a certain threshold.

Automatic controls provide efficient operation by keeping the system in an idle mode until light snow begins to fall and allowing adequate warm-up before a heavy snowfall. Systems that only use manual controls require the building owner to turn on the system when it starts to snow or to leave the system running in snow-melting mode, using significantly more energy.

Best practices	<p>A snow-melting system works by heating a mass or surface so that walkways, driveways, and other areas remain dry and clear. Most snow-melting systems are hydronic, using circulated fluids to heat these outdoor masses, although some use electric heat.</p> <p>Insulation substantially reduces operating cost. When added under the slab and at its perimeter, heat loss into the ground is reduced, and the slab heats faster. The preferred insulation material is usually 1- or 2-inch-thick rigid polystyrene foam R-10. Insulation also helps to channel the heat in the direction it's wanted.</p> <p>Incorporate a "manual on" switch to manually activate the system in the event of a sensor failure or to preheat the slab in advance of an oncoming storm.</p> <p>Incorporate a "manual off" or disable switch to kill the entire system if the owner does not want it to operate. A simple three-way toggle switch with "off-auto-on" points would serve the same purpose.</p>
Common pitfalls	<p>The system performance may be dramatically affected if insulation is not installed under and along the slab. Once the system is off for a period of time, the ground will quickly freeze down to the current frost level. Subsequent start-up times will be delayed due to the amount of energy drawn to the frozen subsoil along with the requirements of the slab itself. The lack of insulation will result in increased response times, greater energy consumption, and potential failure of the system to perform to specification.</p>

R403.10 Pools and Permanent Spa Energy Consumption (Mandatory)

The energy consumption of pools and permanent spas shall be in accordance with Sections R403.10.1 through R403.10.3.

R403.10.1 Heaters. The electric power to heaters shall be controlled by a readily accessible on-off switch that is an integral part of the heater mounted on the exterior of the heater, or external to and within 3 feet of the heater. Operation of such switch shall not change the setting of the heater thermostat. Such switches shall be in addition to a circuit breaker for the power to the heater. Gas-fired heaters shall not be equipped with continuously burning ignition pilots.

R403.10.2 Time switches. Time switches or other control methods that can automatically turn off and on according to a preset schedule shall be installed for heaters and pump motors. Heaters and pump motors that have built-in time switches shall be in compliance with this section.

Exceptions:

- 3. Where public health standards require 24-hour pump operation.*
- 4. Pumps that operate solar- and waste-heat-recovery pool heating systems.*

R403.10.3 Covers. Outdoor heated pools and outdoor permanent spas shall be equipped with a vapor-retardant cover or other approved vapor-retardant means. Outdoor heated pools and outdoor heated permanent spas heated to more than 90 °F (32 °C) shall have a pool cover with a minimum insulation value of R-12.

Exception: Where more than 60% of the energy for heating an outdoor heated pool or outdoor heated permanent spa is from site-recovered energy or solar energy source, covers or other vapor-retardant means shall not be required.

New or modified information from ECCCNY-2014	Modified
Interpretation and Intent	<p><i>This section helps coordinate with requirements found in ASHRAE 90.1 Section 7.4.5 and to help reduce the energy used by pools and inground permanently installed spa systems.</i></p> <p>Many swimming pools located in New York State are heated. Without proper oversight, these are a substantial and unnecessary source of energy use. The Energy Code reduces this energy use by governing three different aspects of pool and permanent spa energy consumption:</p> <ul style="list-style-type: none"> • <i>Heaters (Section R403.10.1)</i> • <i>Time switches to turn off heaters and pumps (Section R403.10.2)</i> • <i>Covers (Section R403.10.3)</i>
Best practices	<p>Swimming pools lose energy in a variety of ways, but evaporation is by far the largest source. Evaporating water requires tremendous amounts of energy. It only takes 1 Btu (British thermal unit) to raise one pound of water one degree, but each pound of 80 °F</p>

	<p>water that evaporates takes a whopping 1,048 Btu of heat out of the pool.</p> <p>The evaporation rate from an outdoor pool varies depending on the pool's temperature, air temperature and humidity, and wind speed at the pool surface. The higher the pool temperature and wind speed and the lower the humidity, the greater the evaporation rate. In windy areas, add a windbreak around the pool, trees, shrubs, or a fence to reduce evaporation. The windbreak needs to be high enough and close enough to the pool that it doesn't create turbulence over the pool, which will increase evaporation. Don't allow the windbreak to shade the pool from the sun, which helps heat it. Design a well-insulated cover to minimize the amount of water evaporation from the pool or spa surface is an effective way of avoiding energy losses. Besides stopping heat loss, a cover saves on pool chemicals by keeping them from evaporating with the water.</p>
Common pitfalls	<p>Be sure to keep operating costs to a minimum by installing an efficient, properly sized heater; using a good quality pool cover; and keeping the heating and filtering system clean and well maintained.</p> <p>If using a propane heater, consult local regulations for the safe use, hook-up, and storage of propane products. These regulations may be under the control of local fire or municipal departments, county building codes, etc. Learn the local regulations and follow them.</p>

5.4.1 R403.11 Portable Spas (Mandatory)

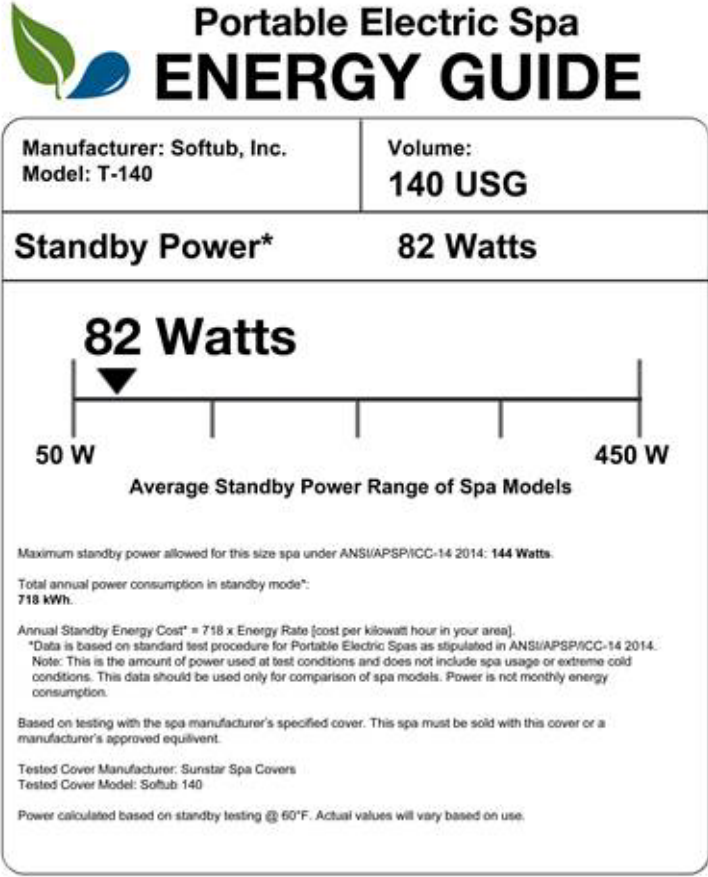
<p><i>The energy consumption of electric-powered portable spas shall be controlled by the requirements of APSP-14.</i></p>	
<p>New or modified information from ECCCNY-2014</p>	<p>New</p>
<p>Interpretation and Intent</p>	<p><i>The standard addresses efficiency requirements for water heating equipment and water circulation pumps.</i></p> <p>This standard covers the test procedures and methodology for determining the energy efficiency of self-contained portable electric spas and hot tubs.</p> <p>This standard does not cover non-self-contained spas, public spas, public swim spas or permanently installed residential spas, or swim spas. This standard requires a comprehensive energy label like the one shown in Figure 31 on each hot tub, enabling consumers to evaluate their choices when making a purchase.</p> <p>Figure 31. Comprehensive energy label for a portable spa</p> 

Best practices	<p>A hot tub should not be purchased simply on the strength of its energy efficiency. If the main use of the tub will be soaking, also consider options with low wattage, small pumps, and fewer gallons of water.</p> <p>Solar energy for portable spas will continue to gain traction as new products enter the market and consumers continue to adopt the carbon neutral lifestyle.</p> <p>Solar water heating provided by low-temperature collectors provides heat of less than 110°F. Swimming pool and spa heating typically use these types of collectors. Solar heat is used as a supplemental heater to keep the spa hot during the day, and at night or during rainy periods, the other spa heater takes over.</p> <p>For best results, use an insulated spa cover to retain the heat and a solar controller to optimize when the solar panels are used, and to maintain safe water temperatures.</p> <p>Wind significantly decreases the spa water temperature while the spa is in use, and improperly sealed cabinets and spa covers allow gusts to penetrate warm air pockets necessary for insulating. Installing privacy walls, fencing, hedges, or using a cover all can protect the spa from drafts.</p> <p>Switching to long-lasting LED lights can save about 80% less energy over most standard spa bulbs and fit in most conventional spa fixtures.</p>
Common pitfalls	<p>Dirty, aged filter cartridges overwork pumps and reduce water flow, diminishing efficiency. Soak filters overnight in a non-foaming filter cleanser, every 3-4 months. Rotate two sets of filters, so a clean and dry spare can be installed with each water change. This will extend the life of filters and keep water circulating more freely.</p> <p>Water can easily freeze in pipes when pools and spas are used during the winter. To avoid this, consider a system that includes freeze protection.</p>

R403.12 Residential Pools and Permanent Residential Spas

<i>Residential swimming pools and permanent residential spas that are accessory to detached one- and two-family dwellings and townhouses three stories or less in height above grade plane and that are available only to the household and its guests shall be in accordance with APSP-15a.</i>	
New or modified information from ECCCNY-2014	New
Interpretation and Intent	The scope of APSP-15a covers energy efficiency requirement for residential swimming pool filtration and heating systems used for bathing and are operated by an owner. This standard is intended to cover certain aspects of the swimming pool filtration and heating system design, equipment, installation, and operation for the purpose of consuming less energy while maintaining water quality and temperature. ⁴⁷
Best practices	Automatic and semi-automatic pool covers can further lower annual heating costs and reduce the need for make-up water. Evaporation can account for up to 70% of energy losses in both indoor and outdoor swimming pools. ⁴⁸
Common pitfalls	This standard does not cover swimming pool safety requirements, including, but not limited to, suction entrapment, structural, thermal, or electrical hazards. This standard provides specifications for energy-efficient filtration systems, but does not specify sanitizer, daily turnover flow rates, or pool-cleaning technologies needed to establish and maintain swimming pool water quality.

⁴⁷ [http://www.consensus.fsu.edu/FBC/Pool-Efficiency/APSP-15%20Pool%20Energy%20language%20\(1-11-10\)%20%20for%20Florida.pdf](http://www.consensus.fsu.edu/FBC/Pool-Efficiency/APSP-15%20Pool%20Energy%20language%20(1-11-10)%20%20for%20Florida.pdf)

⁴⁸ <https://energy.gov/energysaver/swimming-pool-covers>; <https://aquamagazine.com/retail/the-case-for-automatic-pool-covers.html>

R504 Repairs

<p><i>Buildings, structures, and parts thereof shall be repaired in compliance with Section R501.3 and this section. Work on non-damaged components necessary for the required repair of damaged components shall be considered part of the repair and shall not be subject to the requirements for alterations in this chapter. Routine maintenance required by Section R501.3, ordinary repairs exempt from permit, and abatement of wear due to normal service conditions shall not be subject to the requirements for repairs in this section.</i></p>	
New or modified information from ECCCNY-2014	New
Interpretation and Intent	<p><i>Repairs are not required to comply with the Energy Code. For instance, replacing glass in an existing sash and frame does not require the window or door to comply with fenestration requirements for new construction found in Chapter 4 [RE], Section R402.</i></p> <p>Building repairs fall under Chapter 5 [R] Existing Buildings. This provides the requirements for the unique circumstances involved in existing building additions, alterations and repairs. It's essential to define and distinguish the difference between a repair, alteration, and addition because repairs are not subject to the Energy Code, but alterations and additions are (See Definitions section).</p>
Best practices	<p>When any building component is repaired, energy efficiency should be considered. For example, only replacing a bulb or ballast or both within an existing luminaire, this is not subject to the energy code provided the replacement does not increase the installed interior lighting power. However, given new technology, such as LED or CFL light bulbs or electronic ballasts, it is a best practice to replace inefficient lighting such as incandescent, with high-efficiency components. CFL light bulbs have been readily available for many years. LED bulbs are relatively new to the market and have had a high first-cost that made the technology unattractive. Recent advancements in LED manufacturing technology have driven the prices down to a level where LED bulbs are more cost-effective than CFLs or incandescent bulbs. This trend is continuing, with LED bulbs being designed for more applications while the prices are going down over time.</p>
Common pitfalls	<p>Repairs should never increase the preexisting energy consumption of the repaired component, system, or equipment.</p>

5.4.2 R505 Change of occupancy or use

<i>Spaces undergoing a change in occupancy that would result in an increase in demand for either fossil fuel or electrical energy shall comply with this code.</i>	
New or modified information from ECCCNY-2014	New
Interpretation and Intent	When a building undergoes a change of occupancy, the building energy-using systems (envelope, mechanical, service water heating, electrical power and lighting) needs to be evaluated to determine that the change does or does not affect the system performance and energy use.
Best practices	A change of use or occupancy requires a permit. A permit is required to document a change of use or occupancy classification of a building, even where no alterations are planned or required by the code.
Common pitfalls	<p>Changing the use or occupancy of a building involves many considerations. In a change of use or occupancy, almost nothing is grandfathered. For example, an old house that is to be used as an office building must comply with most of the life safety code requirements, such as exiting, that are required for a new office building.</p> <p>Current code requirements must be met, including addressing accessibility for new work and removing existing barriers, potential addition of sprinkler systems, and others.</p>

5.5 Additional residential code provisions

For additional information on these residential Energy Code provisions, please see UGC's Conquer the Code (updated December 2016):

- R401 General
- R402 Building Thermal Envelope
- R403 Systems
- R404 Electric Power and Lighting Systems
- R405 Simulated Performance Alternative
- R501 Existing Buildings
- R502 Additions
- R503 Alterations
- R504 Repairs
- R505 Change of occupancy or use

For frequently asked questions pertaining to the some of the provisions in the above list, please see the Frequently Asked Questions section below. For ease in navigation, the FAQs are listed in the same order as the provisions appear in the Energy Code.

5.6 Frequently asked questions

5.6.1 R401 General

Q: Where can I purchase a hard copy of the Energy Code?

A: It can be purchased from www.iccsafe.org.

R401.1 Scope

Q: How should a new mixed-use building (where the first floor is commercial and the upper two stories are residential apartments) comply with the Energy Code?

A: The commercial portion of the building would fall under the commercial Energy Code. The residential portions of the building would fall under the residential Energy Code. However, if the building were more than three stories tall, the residential portion would have to comply with the residential provisions within the commercial Energy Code.

Q: Do manufactured and mobile homes need to meet the Energy Code?

A: No. Homes bearing the HUD Construction Code label are exempt from the Energy Code.⁴⁹

Q: Does the Energy Code apply to detached garages that are unheated but insulated?

A: Unheated buildings such as this do not have to meet the Energy Code.

⁴⁹ <http://www.ibts.org/what-we-do/manufactured-homes/verification-letter-certificate/>

5.6.2 R401.2 Compliance

Q: What are the Energy Code compliance options?

A: There are two main compliance options: prescriptive and performance. The prescriptive path is the checklist method, requiring a project team to show that a series of building components meets code minimums. The performance path allows for more trade-offs and above-code options with R405 (Simulated Performance Alternative) or R406 (Energy Rating Index Compliance Alternative).

5.6.3 R402 Building Thermal Envelope

R402.1 General (Prescriptive)

Q: Are advanced framing details required by the Energy Code?

A: Advanced framing techniques, though a best practice, are not a current Energy Code requirement.

Q: Will the new Energy Code's envelope provisions cause wall assembly condensation issues within wall assemblies?

A: Dew point condensation issues are somewhat addressed with the allowance of a class III vapor retarder to be used on walls with a ventilated cladding system or continuous insulation on the outside face of the framing. These provisions allow the wall to dry to the interior if any condensation occurs.

Q: Do I need to air seal and insulate cantilevered floors?

A: Yes. The building thermal envelope needs to be continuous cantilevers.

Q: How can a project meet building envelope requirements when a portion of an exterior wall has less than the minimum required insulation?

A: This project must demonstrate compliance via the U-factor alternative, the UA alternative or the performance path.

Q: Are vapor retarders required at the ceiling between conditioned space and ventilated attic space?

A: The Energy Code does not require vapor retarders for properly ventilated cavities.

Q: Are SIPs considered continuous insulation?

A: SIPs are considered to provide continuous insulation.

Q: Do R-38 batts qualify as continuous insulation?

A: No. Batt insulation is considered cavity insulation, not continuous insulation.

5.6.4 R402.2 Specific insulation requirements (Prescriptive)

Q: Can the poly sheathing vapor barrier be left exposed in an attic area behind a knee wall?

A: The long-term integrity of this material when left exposed is uncertain, but the Energy Code does not require it to be covered.

Q: The rafters of a cathedral ceiling are deep enough to accommodate minimum insulation except at the heel. What should be done in this area?

A: First, the area of the cathedral ceiling that will have reduced insulation must not exceed 500 sf or 20%

of the total cathedral roof area. To meet the prescriptive code requirement, you could, for example, use R-6 spray foam insulation to achieve at least R-30.

Q: The designer has reduced the insulation R-value in the floor above a garage. Can they do this without a variance?

A: The designer may do this if they have accounted for the variable insulation in the Energy Code submission documents. They would not be able to use the prescriptive path for compliance when the building in its entirety does not meet the tabular requirements.

Q: Is insulation required beneath a basement slab with insulated foundation walls?

A: This is not required unless the slab contains radiant heating elements or is part of a walkout basement.

R402.3 Fenestration (Prescriptive)

Q: Is there a maximum amount of fenestration allowed for single-family homes?

A: There is no maximum allowable fenestration or glazing area for residential buildings. However, those homes with very large proportions of glazing to wall may not be able to show compliance using REScheck™.

R402.4 Air leakage (Mandatory)

R402.4.1 Building thermal envelope

Q: In cases where a soffit runs adjacent to an exterior wall, why is the air barrier placed next to the thermal envelope instead of following the shape of the soffit?

A: Air barriers must be in continuous alignment and full contact with the thermal envelope. In the case of a soffit along an exterior wall, the area inside the soffit at the thermal layer must have an air barrier in contact with it at that location.

Q: Are insulated headers required by the Energy Code?

A: Insulated headers are required in the prescriptive path. Cavities within corners and headers of framed walls shall be insulated to at least R-3.

Q: What details should be shown on the plans with respect to air sealing?

A: Include specifications where available and/or reference Table R402.4.1.1.

Q: Who is approved to perform blower door and duct blaster tests?

A: Blower door testing can be performed by the code official or by a third-party testing agency or individual with qualifications acceptable to the local code official. NYS does not currently have any minimum certification or training requirements, so appropriate qualifications are at the discretion of the local code official. It is likely that a code official would want to see training or certification by a reputable organization or trainer. A signed report showing the blower door test results should be provided to the code official.

Lists of certified raters and testers:

- <http://www.nehers.org/find-hers-rater>

- <https://www.nyserda.ny.gov/Contractors/Find-a-Contractor/Home-Energy-Raters>
- <http://www.resnet.us/directory/search>
- <http://www.bpihomeowner.org/find-a-contractor>

Q: Can a contractor who is working on a new home conduct blower door testing on that home?

A: The EnergyCode does not disqualify a qualified installer from testing their own work, but the acceptability testing agents is left to the discretion of the local code official.

Q: How should a project team meet the 3ACH50 requirement and show compliance?

A: Use an air leakage checklist and follow established/known means of air sealing the home. Blower door testing is used to demonstrate compliance with this requirement.

Q: Is there a blower door testing protocol for multifamily units?

A: Yes, Sections R402.4.1.2 and R402.4.1.3 specify protocols for testing more than seven units.

R402.4.2 Fireplaces

Q: What are the requirements for open fireplaces?

A: The EnergyCode requires tight fitting glass doors and a source of combustion air on all masonry fireplaces and vented gas or solid fuel fireplaces. This is a mandatory provision.

5.6.5 R403 Systems

R403.1 Controls (Mandatory)

Q: Is electric resistance heat allowed in multi-family units?

A: The EnergyCode does not prohibit the use of electric resistance heat in residential or commercial buildings. Heat pumps with supplemental electric-resistance heat shall have controls as specified in Section R403.1.2.

R403.3 Ducts

Q: Does the Energy Code require ductwork insulation?

A: Yes, in some cases. Insulation is required where ducts extend outside the thermal envelope.

Q: How should ducts in garage ceilings be treated?

A: In homes with unconditioned garages, the garage ceiling forms part of the building envelope. To be considered part of this conditioned envelope, the ductwork in this ceiling assembly would be located up against the second floor of the home, insulated to at least R-6, and air sealed (assuming a diameter greater than 6"). The product used would likely be spray foam or rigid insulation air sealed to the joists. If space remains in the unconditioned portion of the cavity, insulation should be added to achieve R-30 in Climate Zones 5 and 6. Where REScheck™ is used, the total R-value could vary depending on home's other thermal characteristics.

Q: The Energy Code exempts duct testing where ducts are completely inside the thermal envelope. Is duct sealing still required in this case?

A: Yes, duct sealing is a separate mandatory provision and must occur regardless of the ductwork's location in the thermal envelope.

Q: Can interior building cavities be used as supply or return ducts?

A: No. Neither exterior nor interior framing cavities can be used as ducts or plenums.

R403.4 Mechanical system piping insulation

Q: What are the requirements for piping insulation for residential buildings?

A: Insulation is required when piping is $\frac{3}{4}$ " or larger in diameter or when the piping is carrying water from the water heater to a manifold. At least R-3 insulation is required when system piping is carrying fluids above 105 °F or below 55 °F.

R403.6 Mechanical ventilation (Mandatory)

Q: How does the Energy Code address indoor air quality issues caused by the new 3ACH50 requirement?

A: All homes with less than 5ACH50 must provide whole-house mechanical ventilation (WHMV). There are four basic types of WHMV systems: exhaust, supply, balanced, and energy recovery (includes energy recovery ventilators [ERV] and heat recovery ventilators [HRV]).

The Energy Code provides several compliance options using these systems, including the introduction of outside air into the return-air side of the furnace along with the use of timed operations of bath fans. The Energy Code does not require balanced ventilation; a system could be supply only or exhaust only. One or more bath fans can be used as the WHMV system if they are sized according to Table M1507.3.3(1) in the 2015 IRC and have requisite controls. Two smaller fans typically provide better distribution than a single larger fan, but multiple fans is not a code requirement. Fans that run intermittently must be sized using the factors in Table M1507.3.3(2) in the 2015 IRC. Controls must have a manual override. The 2015 IRC also includes provisions on using bathroom fans or kitchen hood fans in combination with passive or mechanical supply air to meet requirements.

Q: Why do unvented crawlspaces have to be directly conditioned?

A: This provision requires a ducted supply of conditioned air at a rate of 1 cfm/50sf and a path/register for return air. This is to assure air movement and circulation in the unvented crawlspace, removing moisture and maintaining reasonable humidity levels.

Q: Does the Energy Code require the controls for a whole-house ventilation system to work in concert with one another when there are two or more fans being used?

A: No, the code would permit the fans to operate as independent operations, without interconnection.

R403.7 Equipment sizing and efficiency rating (Mandatory)

Q: What are the minimum requirements for residential boilers?

A: Minimum efficiency requirements for boilers and furnaces are set at the federal level by DOE. The minimum efficiency standard for gas boilers is 82 AFUE.⁵⁰

Q: What are the minimum requirements for residential air conditioners and heat pumps?

A: DOE also prescribes energy conservation standards for consumer products such as residential air conditioners and heat pump systems. The applicable requirement for air conditioners is the seasonal

⁵⁰ <https://energy.gov/energysaver/furnaces-and-boilers>

energy efficiency ratio (SEER). In NYS, split-system central air conditioners must have a SEER rating of at least 13. Split-system heat pumps, split-package air conditioners, and split-package heat pumps all must have a SEER rating of at least 14.⁵¹

5.6.6 R404 Electric Power and Lighting Systems

Q: Does the Energy Code still allow incandescent lighting?

A: Yes, but no more than 25% of the lamps in permanently installed lighting fixtures may be incandescent. At least 75% of the lamps in those fixtures must be high-efficacy.

5.6.7 R405 Simulated Performance Alternative

Q: How might an all-glass home using on-site renewable energy comply with the Energy Code?

A: A home like this could use REScheck™ calculations as a starting point, then more complex energy modeling software to aid in design decisions. The design team could then use the Energy Rating Index Compliance Alternative (Section R406) to eventually demonstrate code compliance.

Q: A project team has submitted a REM/Rate report to show code compliance using the Simulated Performance Alternative. The project passes using this method but does not pass under the Energy Rating Index Compliance Alternative (Section R406). Is this acceptable?

A: Yes. A project only needs to meet the Energy Code via one compliance path.

Q: What documents should be submitted if a project team has chosen the performance path?

A: Teams should submit completed documentation from an accepted software tool showing which compliance options were selected. Projects still need to meet all mandatory items within the Energy Code.

Q: Is REScheck™ still available as a compliance option with the new Energy Code?

A: REScheck™ is still available for use with the 2015 IECC. DOE no longer offers a NYS-specific code option, so project teams should select the 2015 IECC and proceed with inputs from there.

Q: What are the approved software programs for demonstrating code compliance?

A: There is currently no list of officially approved software from the NYS Secretary of State or other State official. REScheck™, COMcheck™, and REM/Design are approved by DOE to demonstrate prescriptive compliance with the residential and commercial portions of the 2015 IECC.

5.6.8 R501 Existing Buildings

Q: If an existing home has been gutted, which Energy Code provisions does it have to meet?

A: The home does not have to meet the prescriptive insulation requirements of the Energy Code. However, cavities do need to be filled with insulation. Spray foam will offer higher R-value and assist with air sealing, but fiberglass or cellulose insulation can certainly also be used. Care should be taken with respect to sealing around all penetrations of the building envelope. A blower door test is required, and air leakage must be 3ACH50 or less. A duct blaster test must also be performed if the HVAC system

⁵¹ <https://www.energy.gov/sites/prod/files/2015/11/f27/CAC%20Brochure.pdf>

or ductwork is located outside the conditioned building envelope. All provisions related to mechanical systems and lighting must also be met.

5.6.9 R502 Additions

Q: If a project team is making no changes other than those required to open an existing house up for a new addition, do any other parts of the existing home need to meet the current Energy Code?

A: Only the new addition needs to meet new Energy Code requirements.

Q: Is a blower door test required for additions?

A: Yes, this testing is required for all additions. The Energy Code states that new building envelope assemblies in additions must comply with Section R402.4, which specifies air tightness testing requirements for buildings and dwelling units. There are two recommended options for conducting blower door tests on additions:

- Conduct testing on the existing home before any work begins. After the addition is completed, conduct a second blower door test using the new volume of the home. By comparing these numbers, a project team can calculate if the new addition meets the 3ACH50 requirement.
- Isolate the addition from the existing home and conduct a blower door test on the addition only. This method is more involved and may not be practical, especially if the addition is multiple stories tall or includes a basement or crawlspace.

Note: NYSDOS has issued a technical bulletin permitting a visual inspection of the components listed in Table R402.4.1.1 to suffice in cases where testing non-isolated building additions would be too difficult.⁵²

Q: Is mechanical ventilation required for additions?

A: Yes. Since additions are required to comply with the same air tightness requirements as other types of residential construction, they must meet ACH requirements for whole-house mechanical ventilation.

Q: Is a HERS rating required for additions?

A: There is no code requirement for a HERS rating. However, many local jurisdictions have written HERS-specific language into their energy code amendments.

5.6.10 R503 Alterations

Q: A previously unconditioned building is being retrofitted with air conditioning. If the project meets prescriptive envelope requirements, does the project team also need to submit a REScheck™ report?

A: No, meeting the prescriptive requirements of either Table R402.1.2 or Table R402.1.4 is sufficient. REScheck™ is not required, but all mandatory envelope provisions, mechanical system provisions, and lighting requirements must be met.

Q: Can heating and cooling systems be installed in existing buildings without bringing the entire building up to code?

⁵² <https://www.dos.ny.gov/DCEA/pdf/TB-1020-RCNYS---Blower%20Test--Air%20Infiltration.pdf>

A: No. When unconditioned space is converted into conditioned space, the entire space must meet Energy Code requirements, including those for building thermal envelope and lighting.

Q: If a home is being remodeled, does its wall insulation need to be brought up to code?

A: Only if the walls are exposed during the process, in which case they only need to be filled with insulation. There is no need to bring the R-value of existing building cavities up to the current Energy Code requirements. For example, the code does not require you to install continuous insulation if you cannot meet the prescriptive code-required R-value.

5.6.11 Documentation and Inspections

Q: What documentation should be shown on plans to comply with the Energy Code?

A: Documentation should include, for example, detailed information on air sealing and insulation levels, window information, and HVAC systems. Please review the residential provisions of the Energy Code and be clear when indicating to the code officials which compliance path has been selected.

Q: Where can I find good examples of how to show details and specifications on plans?

A: There are freely available details (.rvt, .dwg and .pdf formats) located on the Building America Solution Center (BASC) website.

Q: Are builders required to submit a Manual J and Manual S to demonstrate code compliance?

A: Manual J and Manual S or other approved engineering documents are required by the residential Energy Code. Manual J is the heat loss/heat gain calculation; Manual S is used to size equipment properly based on the Manual J calculated loads. These can be done by any qualified person on the design team.

Q: Does NYS license HERSraters? Is a list of licensed raters available?

A: HERSraters are not licensed by NYS, but NYSERDA does maintain a map of HERSraters:

nysERDA.ny.gov/Contractors/Find-a-Contractor/Home-Energy-Raters

Appendix A: ECCCNY-2016 Commercial Prescriptive Tables

Section C402: Building Thermal Envelope

Table C402.1.3 Opaque thermal envelope insulation component minimum requirements, R-value method							
		Climate Zone 4		Climate Zone 5		Climate Zone 6	
		All other	Group R	All other	Group R	All other	Group R
Roofs	Insulation entirely above roof deck	R-30ci	R-30ci	R-30ci	R-30ci	R-30ci	R-30ci
	Metal buildings ⁵³	R-19 + R-11 LS ⁵⁴	R-19 + R-11 LS	R-19 + R-11 LS	R-19 + R-11 LS	R-25 + R-11 LS	R-25 + R-11 LS
	Attic and other	R-38	R-38	R-38	R-49	R-49	R-49
Walls, above grade	Mass	R-9.5ci	R-11.4ci	R-11.4ci	R-13.3ci	R-13.3ci	R-15.2ci
	Metal building	R-13 + R-13ci	R-13 + R-13ci	R-13 + R-13ci	R-13 + R-13ci	R-13 + R-13ci	R-13 + R-13ci
	Metal framed	R-13 + R-7.5ci	R-13 + R-7.5ci	R-13 + R-7.5ci	R-13 + R-7.5ci	R-13 + R-7.5ci	R-13 + R-7.5ci
	Wood framed and other	R-13 + R-3.8ci or R-20	R-13 + R-3.8ci or R-20	R-13 + R-3.8ci or R-20	R-13 + R-7.5ci or R-20 + R-3.8ci	R-13 + R-7.5ci or R-20 + R-3.8ci	R-13 + R-7.5ci or R-20 + R-3.8ci
Below-grade wall⁵⁵		R-7.5ci	R-7.5ci	R-7.5ci	R-7.5ci	R-7.5ci	R-7.5ci
Floors	Mass ⁵⁶	R-10ci	R-10.4ci	R-10ci	R-12.5ci	R-12.5ci	R-12.5ci
	Joist/framing	R-30	R-30	R-30	R-30	R-30	R-30
	Steel floor joist systems	R-38	R-38	R-38	R-38	R-38	R-38
Slab-on-grade floors	Unheated slabs	R-10 for 24" below	R-10 for 24" below	R-10 for 24" below	R-10 for 24" below	R-10 for 24" below	R-15 for 24" below
	Heated slabs	R-15 for 24" below	R-15 for 24" below	R-15 for 36" below	R-15 for 36" below	R-15 for 36" below	R-20 for 48" below

⁵³ Where using R-value compliance method, a thermal spacer block shall be provided.

⁵⁴ LS = Liner system

⁵⁵ Where heated slabs are below grade, below-grade walls shall comply with the exterior insulation requirements for heated slabs.

⁵⁶ Mass floors shall include floors weighing not less than: (1) 35 lbs per ft² of floor surface area; or (2) 25 lbs per ft²

Opaque doors	Non-swinging	R-4.75	R-4.75	R-4.75	R-4.75	R-4.75	R-4.75
---------------------	--------------	--------	--------	--------	--------	--------	--------

Table C402.1.4 Opaque thermal envelope assembly maximum requirements, U-factor method							
Component type		Climate Zone 4		Climate Zone 5		Climate Zone 6	
		All other	Group R	All other	Group R	All other	Group R
Roofs	Insulation entirely above roof deck		U-0.032	U-0.032	U-0.032	U-0.032	U-0.032
	Metal buildings		U-0.035	U-0.035	U-0.035	U-0.035	U-0.031
	Attic and other		U-0.027	U-0.027	U-0.027	U-0.021	U-0.021
Walls	Above grade	Mass	U-0.104	U-0.090	U-0.090	U-0.080	U-0.071
		Metal building	U-0.052	U-0.052	U-0.052	U-0.052	U-0.052
		Metal framed	U-0.064	U-0.064	U-0.064	U-0.064	U-0.064
		Wood framed and other	U-0.064	U-0.064	U-0.064	U-0.064	U-0.051
	Below grade	All components	C-0.119	C-0.119	C-0.119	C-0.119	C-0.119
Floors	Mass		U-0.076	U-0.074	U-0.074	U-0.064	U-0.057
	Joist/framing		U-0.033	U-0.033	U-0.033	U-0.033	U-0.033
Slab-on-grade floors	Unheated slabs		F-0.54	F-0.54	F-0.54	F-0.54	F-0.52
	Heated slabs ⁵⁷		F-0.65	F-0.65	F-0.65	F-0.65	F-0.58
Opaque doors	Non-swinging		U-0.61	U-0.61	U-0.37	U-0.37	U-0.37

Table C402.1.4.1 Effective R-values for steel stud wall assemblies				
Nominal stud depth (in.)	Spacing of framing (in.)	Cavity R-value	Correction Factor (F _c)	Effective R-value (ER) (Cavity R-value x F _c)
3 ½	16	13	0.46	5.98
		15	0.43	6.45
3 ½	24	13	0.55	7.15
		15	0.52	7.80
6	16	19	0.37	7.03

⁵⁷ Evidence of compliance with the F-factors indicated in the table for heated slabs shall be demonstrated by the application of the unheated slab F-factors and R-values derived from ASHRAE 90.1 Appendix A.

		21	0.35	7.35
6	24	19	0.45	8.55
		21	0.43	9.03
8	16	25	0.31	7.75
	24	25	0.38	9.50

Table C402.4 Building envelope fenestration maximum U-factor and SHGC requirements					
			Climate Zone		
Building component			4	5	6
Vertical fenestration	U-factor	Fixed fenestration	0.38	0.38	0.36
		Operable fenestration	0.45	0.45	0.43
		Entrance doors	0.77	0.77	0.77
	SHGC	PF < 0.2	0.40	0.40	0.40
		0.2 ≤ PF < 0.5	0.48	0.48	0.48
		PF ≥ 0.5	0.64	0.64	0.64
Skylights	U-factor	0.50	0.50	0.50	
	SHGC	0.40	0.40	0.40	

Table C402.5.2 Maximum air leakage rate for fenestration assemblies		
Fenestration Assembly	Maximum Rate (cfm/ft ²)	Test procedure
Windows	0.20 ⁵⁸	AAMA/WDMA/ CSA101/I.S.2/A440 or NFRC 400
Sliding doors	0.20	
Swinging doors	0.20	
Skylights – with condensation weepage openings	0.30	
Skylights – all other	0.20	
Curtain walls	0.06	NFRC 400 or ASTM E283

⁵⁸ The maximum rate for windows, sliding and swinging doors, and skylights is permitted to be 0.3 cfm per ft² of fenestration or door area when tested in accordance with AAMA/WDMA/CSA101/I.S.2/A440 at 6.24 psf.

Storefront glazing	0.06	at 1.57 psf
Commercial glazing swinging entrance doors	1.00	
Revolving doors	1.00	
Garage doors	0.40	ANSI/DASMA 105, NFRC 400, or ASTM E283 at 1.57 psf
Rolling doors	1.00	
High-speed doors	1.30	

Appendix B: ECCCNY-2016 Residential Prescriptive Tables

B.1 Section R402: Building Thermal Envelope

Table R402.1.2 Insulation and fenestration requirements by component				
	Climate Zone			
	4	5	6	
			Option 1	Option 2
Fenestration <i>U</i> -factor	0.35	0.32	0.32	0.28
Skylight <i>U</i> -factor	0.55	0.55	0.55	0.55
Glazed fenestration SHGC	0.40	NR	NR	NR
Ceiling <i>R</i> -value	R-49	R-49	R-49	R-49
Wood frame wall <i>R</i> -value	R-20 or R-13 + R-5ci	R-20 or R-13 + R-5ci	R-20 + R-5ci or R-13 + R-10ci	R-25
Mass wall <i>R</i> -value ⁵⁹	R-8/R-13	R-13/R-17	R-15/R-20	R-15/R-20
Floor <i>R</i> -value	R-19	R-30	R-30	R-30
Basement wall <i>R</i> -value	R-10/R-13	R-15/R-19	R-15/R-19	R-15/R-12
Slab <i>R</i> -value and depth	R-10, 2'	R-10, 2'	R-15, 4'	R-15, 4'
Crawl space wall <i>R</i> -value	R-10/R-13	R-15/R-19	R-15/R-19	R-15/R-20

Table R402.1.4 Equivalent <i>U</i> -factors								
Climate Zone	Fenestration	Skylight	Ceiling	Frame wall	Mass wall	Floor	Basement wall	Crawl space wall
4	0.36	0.55	0.026	0.060	0.098	0.047	0.059	0.065
5	0.32	0.55	0.026	0.060	0.082	0.033	0.050	0.055
6	0.32	0.55	0.026	0.045	0.060	0.033	0.050	0.055

⁵⁹ The second *R*-value applies when more than half of the insulation is on the interior of the mass wall.

Table R402.2.6		
Steel-frame ceiling, wall and floor insulation (R-value)		
	Wood frame requirement	Cold-formed steel equivalent
Steel truss ceilings	R-30	R-38 or R-30 + R-3ci or R-26 + R-5ci
	R-38	R-49 or R-38 + R-3ci
	R-49	R-38 + R-5ci
Steel joist ceilings	R-30	R-38 in 2x4 or 2x6 or 2x8 R-49 in any framing
	R-38	R-49 in 2x4 or 2x6 or 2x8 or 2x10
Steel-framed wall 16" on center	R-13	R-13 + R-4.2ci or R-19 + R-2.1ci or R-21 + R-2.8ci or R-0 + R-9.3ci or R-15 + R-3.8ci or R-21 + R-3.1ci
	R-13 + R-3ci	R-0 + R-11.2ci or R-13 + R-6.1ci or R-15 + R-5.7ci or R-19 + R-5.0ci or R-21 + R-4.7ci
	R-20	R-0 + R-14.0ci or R-13 + R-8.9ci or R-15 + R-8.5ci or R-19 + R-7.8ci or R-19 + R-6.2ci or R-21 + R-7.5ci
	R-20 + R-5ci	R-13 + R-12.7ci or R-15 + R-12.3ci or R-19 + R-11.6ci or R-21 + R-11.3ci or R-25 + R-10.9ci
	R-21	R-0 + R-14.6ci or R-13 + R-9.5ci or R-15 + R-9.1ci or R-19 + R-8.4ci or R-21 + R-8.1ci or R-25 + R-7.7ci
Steel-framed wall 24" on center	R-13	R-0 + R-9.3ci or R-13 + R-3.0ci or R-15 + R-2.4ci
	R-13 + R-3ci	R-0 + R-11.2ci or R-13 + R-4.9ci or R-15 + R-4.3ci or R-19 + R-3.5ci or R-21 + R-3.1ci
	R-20	R-0 + R-14.0ci or R-13 + R-7.7ci or R-15 + R-7.1ci or R-19 + R-6.3ci or R-21 + R-5.9ci
	R-20 + R-5ci	R-13 + R-11.5ci or R-15 + R-10.9ci or R-19 + R-10.1ci or R-21 + R-9.7ci or R-25 + R-9.1ci
	R-21	R-0 + R-14.6ci or R-13 + R-8.3ci or R-15 + R-7.7ci or R-19 + R-6.9ci or R-21 + R-6.5ci or R-25 + R-5.9ci
Steel joist floor	R-13	R-19 in 2x6 or R-19 + R-6ci in 2x8 or 2x10
	R-19	R-19 + R-6ci in 2x6 or R-19 + R-12ci in 2x8 or 2x10

Table R402.4.1.1

Air barrier and insulation installation

Component	Air barrier criteria	Insulation installation criteria
General requirements	<p>A continuous air barrier shall be installed in the building envelope.</p> <p>The exterior thermal envelope shall contain a continuous air barrier.</p> <p>Breaks or joints in the air barrier shall be sealed.</p>	Air-permeable insulation shall not be used as a sealing material.
Ceiling/attic	<p>The air barrier in any dropped ceiling/soffit shall be aligned with the insulation and any gaps in the air barrier shall be sealed.</p> <p>Access openings, drop-down stairs, or knee wall doors to unconditioned attic spaces shall be sealed.</p>	The insulation in any dropped ceiling/soffit shall be aligned with the air barrier.
Walls	<p>The junction of the foundation and sill plate shall be sealed.</p> <p>The junction of the top plate and the top of exterior walls shall be sealed.</p> <p>Knee walls shall be sealed.</p>	<p>Cavities within corners and headers of frame walls shall be insulated by completely filling the cavity with a material having a thermal resistance of R-3 per inch minimum.</p> <p>Exterior thermal envelope insulation for framed walls shall be installed in substantial contact and continuous alignment with the air barrier.</p>
Windows, skylights and doors	The space between window/door jambs and framing, and skylights and framing shall be sealed.	
Rim joists	Rim joists shall include the air barrier.	Rim joists shall be insulated.
Floors (including above garage and cantilevered floors)	The air barrier shall be installed at any exposed edge of insulation.	Floor-framing cavity insulation shall be installed to maintain permanent contact with the underside of subfloor decking, or floor framing cavity insulation shall be permitted to be in contact with the top side of sheathing, or continuous insulation installed on the underside of floor framing and extends from the bottom to the top of all perimeter floor framing members.
Crawl space walls	Exposed earth in unvented crawl spaces shall be covered with a Class I vapor retarder with overlapping joints taped.	Where provided instead of floor insulation, insulation shall be permanently attached to the crawlspace walls.

Shafts, penetrations	Duct shafts, utility penetrations, and flue shafts opening to the exterior or unconditioned space shall be sealed.	
Narrow cavities		Batts in narrow cavities shall be cut to fit, or narrow cavities shall be filled by insulation that on installation readily conforms to the available cavity space.
Garage separation	Air sealing shall be provided between the garage and conditioned spaces.	
Recessed lighting	Recessed light fixtures installed in the building thermal envelope shall be sealed to the drywall.	Recessed light fixtures installed in the building thermal envelope shall be air tight and IC rated.
Plumbing and wiring		Batt insulation shall be cut neatly to fit around wiring and plumbing in exterior walls, or insulation that on installation readily conforms to available space shall extend behind piping and wiring.
Shower/tub on exterior wall	The air barrier installed at exterior walls adjacent to showers and tubs shall separate them from the showers and tubs.	Exterior walls adjacent to showers and tubs shall be insulated.
Electrical/phone box on exterior wall	The air barrier shall be installed behind electrical or communication boxes or air-sealed boxes shall be installed.	
HVAC register boots	HVAC register boots that penetrate building thermal envelope shall be sealed to the subfloor or drywall.	
Concealed sprinklers	When required to be sealed, concealed fire sprinklers shall only be sealed in a manner that is recommended by the manufacturer. Caulking or other adhesive sealants shall not be used to fill voids between fire sprinkler cover plates and walls or ceilings.	

Appendix C: Additional Tools and Resources

This section lists recommended publications and websites that offer specific guidance on all aspects of the Energy Code.

- Article 11 <https://law.justia.com/codes/new-york/2016/eng/article-11/>
 - Article 18 <https://law.justia.com/codes/new-york/2016/exc/article-18/>
 - ASHRAE <https://www.ashrae.org/>
 - Build Smart NY <https://www.nypa.gov/innovation/programs/buildsmart-ny>
 - Building Codes Assistance Project <http://bcapcodes.org/>
 - Building Science Corporation <https://buildingscience.com/>
 - Green Building Advisor <http://www.greenbuildingadvisor.com/>
 - ICC 2015 codes adopted by New York State can be viewed at no cost at: <http://codes.iccsafe.org/New%20York%20State.html#2015>
 - New York State Department of State (NYS DOS) <https://www.dos.ny.gov/>
 - New York State Energy Research and Development Authority (NYSERDA) nysesda.ny.gov/
 - New York State Executive Order 88 <http://www.governor.ny.gov/news/no-88-directing-state-agencies-and-authorities-improve-energy-efficiency-state-buildings>
 - Reforming the Energy Vision (REV) <https://rev.ny.gov/>
 - U.S. Department of Energy (US DOE) <https://energy.gov/>
 - U.S. Environmental Protection Agency (U.S. EPA) <https://www.epa.gov/>
- 2016 Supplement to the New York State Energy Conservation Construction Code (Revised August 2016) "Revised August 2016" <https://www.dos.ny.gov/dcea/pdf/2016%20EC%20Supp- Revised-2016-08-12-approved%20bycouncil%20V-A.pdf>

Appendix D: Image credits

Figure	Description	Credit
1	NYS source EUI reductions in state buildings since 2011	NYPA
2	Main documents of the ECCCNY-2016	BCAP
3	Composition of the NYS Code Council	BCAP
4	Notice of adoption for the ECCCNY-2016	NYS
5	Major steps towards energy code compliance	BCAP
6	NYS climate zone map	BCAP
7	ECCCNY-2016 compliance path options	BCAP
8	Screen capture from COMcheck software	DOE
9	Tight-fitting door requirements for natural-draft fireplaces	BCAP
10	Requirements for certain new wood-burning fireplaces and fireplace units	BCAP
11	Varieties of commercial doors	BCAP
12	A code compliant stucco wall assembly	BCAP
13	Types of chillers	BCAP
14	Example of a complex commercial HVAC system with chiller	DOE
15	AHRI 550/590 test conditions for water-cooled centrifugal chilling packages	BCAP
16	Schematic diagram of a typical rooftop commercial air-handling unit	BCAP
17	Main components of a water-cooled centrifugal chiller	BCAP
18	Commercial kitchen exhaust system	BCAP
19	Potential air leakage spots in exhaust systems	BCAP
20	Air-side economizer	DOE
21	DWHR unit showing placement of heat exchanger	BCAP
22	Basic energy requirements for pools and permanent spas	BCAP
23	Wall with partial structural sheathing at corner	BCAP
24	Sunroom insulation requirements	BCAP
25	Plan view of a tenant separation wall between adjacent dwelling units	BCAP
26	Example of a heat trace system leading to a residential bathroom	BCAP
27	Detail of electric heat tracing cable with attachment tape	BCAP
28	Demand recirculation system cycle	BCAP
29	Typical system using a cold-water supply line	BCAP
30	Snow and ice melt system sensor placement	BCAP
31	Comprehensive energy label for a portable spa	APSP



State of New York

Andrew M. Cuomo, Governor

New York State Energy Research and Development Authority

Richard L. Kauffman, Chair | Alicia Barton, President and CEO